

**SONY**<sup>®</sup>

# User guide

Xperia™ Z2 Tablet  
SGP521

# Contents

<b>Getting started</b> .....	<b>6</b>
About this User guide.....	6
Overview.....	6
Assembly.....	7
Starting your device for the first time.....	9
Why do I need a Google™ account?.....	9
Charging your device.....	10
<b>Learning the basics</b> .....	<b>11</b>
Using the touchscreen.....	11
Locking and unlocking the screen.....	12
Home screen.....	13
Application screen.....	14
Navigating applications.....	15
Small apps.....	15
Widgets.....	16
Shortcuts and folders.....	17
Background and themes.....	18
Taking a screenshot.....	18
Status and notifications.....	18
Icons in the status bar.....	19
Application overview.....	21
<b>Downloading applications</b> .....	<b>23</b>
Downloading applications from Google Play™.....	23
Downloading applications from other sources.....	23
<b>Internet and networks</b> .....	<b>24</b>
Browsing the web.....	24
Internet and MMS settings .....	24
Wi-Fi®.....	25
Sharing your mobile data connection.....	27
Tethering with Xperia Link™.....	28
Controlling data usage.....	29
Selecting mobile networks.....	29
Virtual private networks (VPNs).....	30
<b>Synchronising data on your device</b> .....	<b>31</b>
Synchronising with online accounts.....	31
Synchronising with Microsoft® Exchange ActiveSync®.....	31
Synchronising with Outlook® using a computer.....	32
<b>Basic settings</b> .....	<b>34</b>
Accessing settings.....	34

Sound, ringtone and volume.....	34
SIM card protection.....	35
Screen settings.....	36
Screen lock.....	36
Language settings.....	38
Date and time.....	38
X-Reality™ for mobile.....	39
Super-vivid mode.....	39
Enhancing the sound output.....	39
Noise cancellation.....	40
<b>Typing text.....</b>	<b>41</b>
On-screen keyboard.....	41
Entering text using voice input.....	42
Editing text.....	42
Personalising the Xperia keyboard.....	43
<b>Calling.....</b>	<b>44</b>
Making calls.....	44
Receiving calls.....	45
Ongoing calls.....	46
Using the call log.....	47
Forwarding calls.....	47
Restricting calls.....	47
Multiple calls.....	48
Conference calls.....	49
Voicemail.....	49
Emergency calls.....	49
<b>Contacts.....</b>	<b>51</b>
Transferring contacts.....	51
Searching and viewing contacts.....	52
Adding and editing contacts.....	53
Favourites and groups.....	54
Sending contact information.....	54
Avoiding duplicate entries in the Contacts application.....	54
Backing up contacts.....	55
<b>Messaging and chat.....</b>	<b>56</b>
Reading and sending messages.....	56
Organising your messages.....	57
Calling from a message.....	58
Messaging settings.....	58
Instant messaging and video chat.....	58
<b>Email.....</b>	<b>59</b>
Setting up email.....	59

Sending and receiving email messages.....	59
Email preview pane.....	60
Organising your email messages.....	61
Email account settings.....	61
Gmail™.....	62
<b>Music.....</b>	<b>63</b>
Transferring music to your device.....	63
Listening to music.....	63
Walkman® home screen menu.....	64
Playlists.....	65
Sharing music.....	66
Enhancing the sound.....	66
Visualiser .....	67
Recognising music with TrackID™.....	67
Music Unlimited online service.....	68
<b>FM radio.....</b>	<b>69</b>
Listening to the radio.....	69
Favourite radio channels.....	70
Sound settings.....	70
<b>Camera.....</b>	<b>71</b>
Taking photos and recording videos.....	71
Face detection.....	72
Using Smile Shutter™ to capture smiling faces.....	72
Adding the geographical position to your photos.....	73
General camera settings.....	73
Still camera settings.....	76
Video camera settings.....	79
<b>Photos and videos in Album.....</b>	<b>83</b>
Viewing photos and videos.....	83
Sharing and managing photos and videos.....	84
Editing photos with the Photo editor application.....	85
Album home screen menu.....	86
Viewing your photos on a map.....	87
<b>Videos.....</b>	<b>89</b>
Watching videos in the Movies application.....	89
Transferring video content to your device.....	90
Managing video content.....	90
Video Unlimited service.....	90
<b>Connectivity.....</b>	<b>92</b>
Mirroring the screen of your device on a TV using a cable.....	92
Mirroring the screen of another Xperia™ device wirelessly on your device .....	92

Mirroring the screen of your device wirelessly on a TV.....	93
Sharing content with DLNA Certified™ devices.....	93
Connecting your device to USB mass storage devices.....	95
Playing games on a TV using a DUALSHOCK™3/ DUALSHOCK™4 wireless controller.....	96
NFC.....	97
Bluetooth® wireless technology.....	99
One-touch setup.....	101
<b>Smart apps and features that save you time.....</b>	<b>102</b>
Controlling accessories and settings with Smart Connect.....	102
Using your device as a fitness hub with ANT+™.....	103
Using your device as a wallet.....	103
<b>Travel and maps.....</b>	<b>105</b>
Using location services.....	105
Google Maps™ and navigation.....	105
Using data traffic when travelling.....	106
Using your device with a car infotainment system.....	107
Airplane mode.....	107
<b>Calendar and alarm clock.....</b>	<b>109</b>
Calendar.....	109
Alarm and clock.....	110
<b>Support and maintenance.....</b>	<b>112</b>
Support for your device.....	112
Computer tools.....	112
Updating your device.....	113
Finding a lost device .....	115
IMEI number.....	115
Battery and power management.....	116
Memory and storage.....	117
Managing files using a computer.....	118
Backing up and restoring content.....	119
Restarting and resetting.....	121
Using your device in wet and dusty conditions.....	122
Recycling your device.....	123
Limitations to services and features.....	123
Legal information.....	124

# Getting started

## About this User guide

This is the **Xperia™ Z2 Tablet** User guide for the **Android™ 4.4.4** software version. If you're not sure which software version your device is running, you can check it via the Settings menu. For more information about software updates, see *Updating your device* on page 113.

To check the current software version of your device

- 1 From your Home screen, tap .
- 2 Find and tap **Settings** > **About tablet** > **Android version**.

## Overview

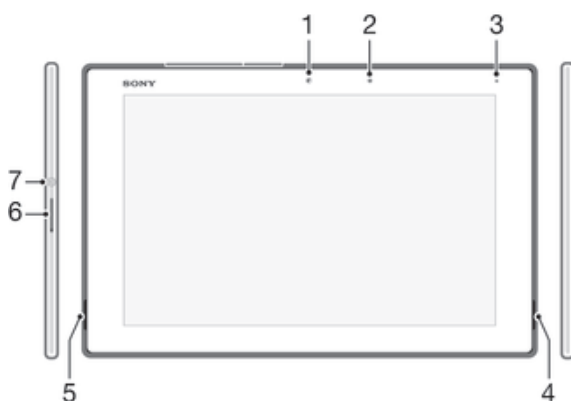

- 1 Front camera
- 2 Light sensor
- 3 Charging/Notification light
- 4 Speaker A
- 5 Speaker B
- 6 Volume/Zoom key
- 7 Power key

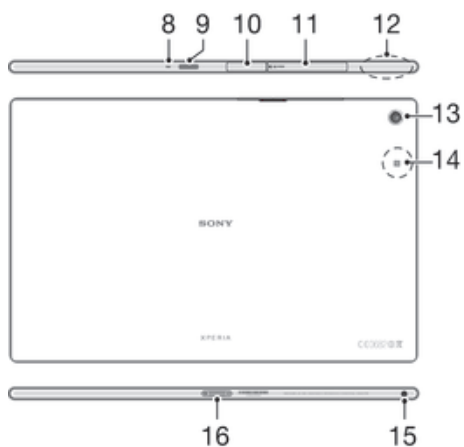

- 8 Microphone
- 9 Infrared sensor
- 10 Charger/USB port cover

11 Memory card/Micro SIM card slot cover

12 **Wi-Fi**/GPS/Bluetooth antenna area

13 Main camera

14 **NFC™** detection area

15 Headset jack

16 Charging dock connector

## Assembly

A protective plastic sheet is attached to the screen. You should peel off this sheet before using the touchscreen. Otherwise, the touchscreen might not function properly.

### To insert the micro SIM card

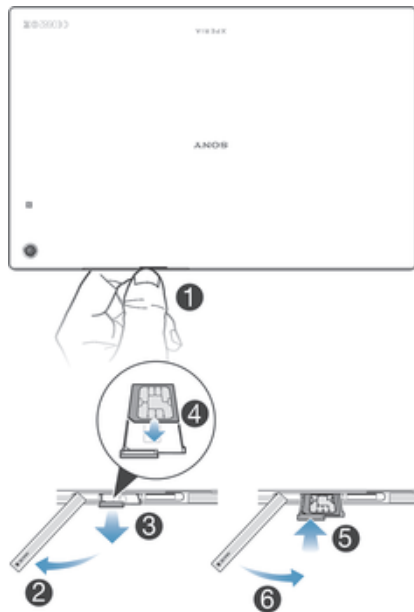

- 1 Insert a fingernail into the gap between the micro SIM card slot cover and the device, then detach the cover.
  - 2 Using a fingernail, pull out the micro SIM card holder.
  - 3 Place the micro SIM card on the holder, with the gold-coloured contacts on the micro SIM card facing up.
  - 4 Insert the micro SIM card holder back into the device.
  - 5 Re-attach the micro SIM card slot cover.
- !** Inserting the micro SIM card into the device without the SIM card holder could damage your micro SIM card or your device, and Sony Mobile does not warrant and will not be responsible for any damage caused by such action.

### To remove the micro SIM card

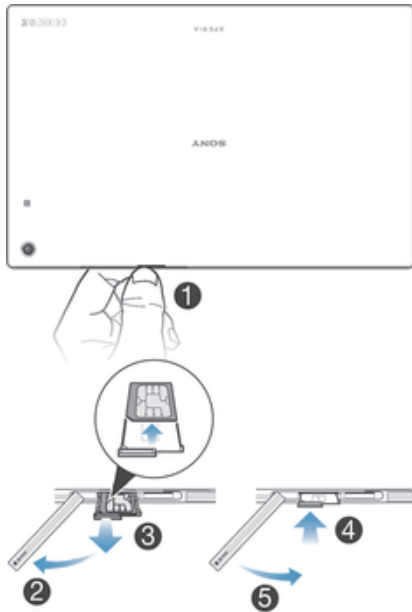

- 1 Remove the cover of the micro SIM card slot.
- 2 Pull out the micro SIM card holder.
- 3 Remove the micro SIM card.
- 4 Insert the micro SIM card holder back into its slot.
- 5 Re-attach the micro SIM card slot cover.

### To insert a memory card

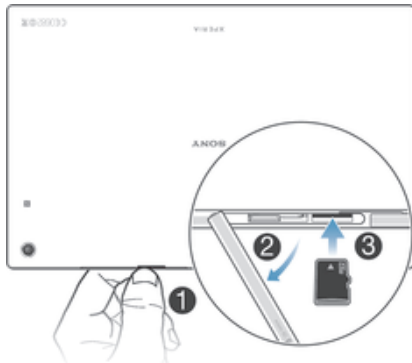

- 1 Insert a fingernail into the gap between the memory card slot cover and the top side of the device, then detach the cover.
- 2 Place the memory card in the memory card slot, with the gold-coloured contacts facing down, then push the memory card all the way into the slot until you hear a locking sound.
- 3 Reattach the memory card cover.

### To remove the memory card

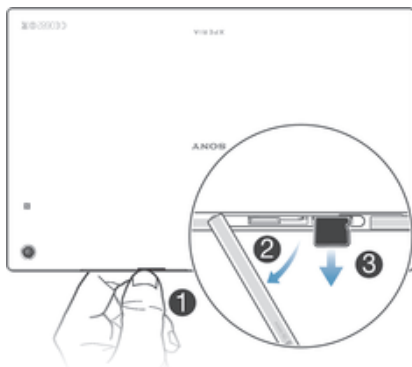



- 1 Turn off the device.
- 2 Remove the cover of the memory card slot, then press against the edge of the memory card and release it.
- 3 Draw the card outwards to remove it fully.

## Starting your device for the first time



The first time you start your device, a setup guide opens to help you configure basic settings, sign in to some accounts, and personalise your device. For example, if you have a Sony Entertainment Network account, you can sign in to it here and get set up straight away. And you can download Internet and Wi-Fi® settings.

- 💡 You can also access the setup guide later from the Settings menu.

### To turn on the device

- ! Make sure that the battery is charged for at least 30 minutes before you turn on the device for the first time.



- 1 Press and hold down the power key  until the device vibrates.
- 2 Enter your SIM card PIN when requested, then tap .
- 3 Wait a while for the device to start.

- 💡 Your SIM card PIN is initially supplied by your network operator, but you can change it later from the Settings menu. To correct a mistake made while entering your SIM card PIN, tap .

### To turn off the device

- 1 Press and hold down the power key  until the options menu opens.
- 2 In the options menu, tap **Power off**.
- 3 Tap **OK**.

- ! It may take a while for the device to shut down.

## Why do I need a Google™ account?

Your Xperia™ device from Sony runs on the Android™ platform developed by Google™. A range of Google™ applications and services is available on your device when you purchase it, for example, Gmail™, Google Maps™, YouTube™ and Google Play™, the online store for downloading Android™ applications. To get the most out of these services, you need a Google™ account. For example, a Google™ account is mandatory if you want to:

- Download and install applications from Google Play™.
- Synchronise email, contacts and the calendar.
- Chat with friends using the Hangouts™ application.
- Synchronise your browsing history and bookmarks.

For more information about Android™ and Google™, go to [www.sonymobile.com/support](http://www.sonymobile.com/support).

## To set up a Google™ account on your device

- 1 From your Home screen, tap .
- 2 Find and tap **Settings** > **Add account** > **Google**.
- 3 Follow the registration wizard to create a Google™ account, or sign in if you already have an account.

 You can also sign in to or create a Google™ account from the setup guide the first time you start your device. Or you can go online and create an account at [www.google.com/accounts](http://www.google.com/accounts).



## Charging your device

The battery is partly charged when you buy the device. You can still use your device while it is charging. Read more about the battery and how to improve the performance in *Battery and power management* on page 116.

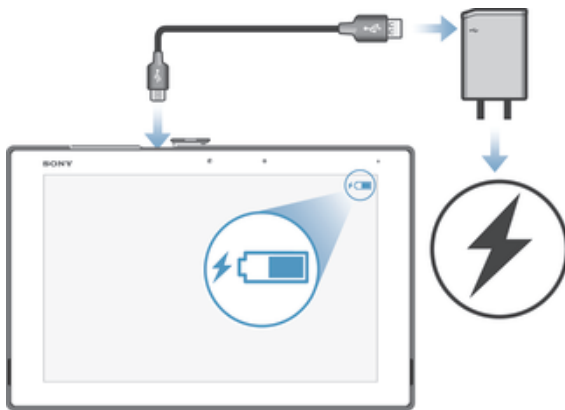
### To charge your device



- 1 Plug the charger into a power outlet.
- 2 Plug one end of the USB cable into the charger (or into the USB port of a computer).
- 3 Plug the other end of the cable into the micro USB port on your device, with the USB symbol facing up. The notification light illuminates when charging begins.
- 4 When the device is fully charged, disconnect the cable from your device by pulling it straight outwards. Make sure not to bend the connector.

 If the battery is completely discharged, it may take a few minutes before the notification light illuminates and the charging icon  appears.

## Battery notification light status

Green	The battery charge level is greater than 90%
Flashing red	The battery is charging and the battery charge level is less than 15%
Orange	The battery is charging and the battery charge level is less than 90%

# Learning the basics

## Using the touchscreen

### Tapping



- Open or select an item.
- Mark or unmark a checkbox or option.
- Enter text using the on-screen keyboard.

### Touching and holding

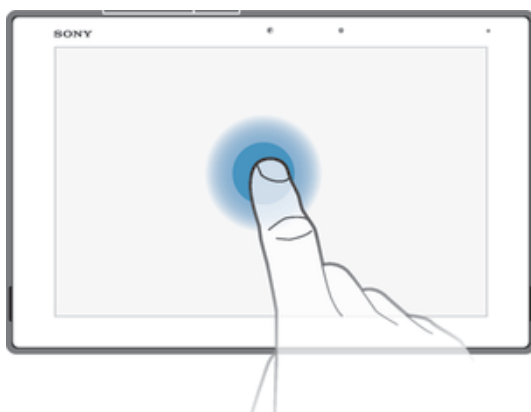

- Move an item.
- Activate an item-specific menu.
- Activate selection mode, for example, to select several items from a list.

### Pinching and spreading



- Zoom in or out on a web page, a photo or a map.

## Swiping

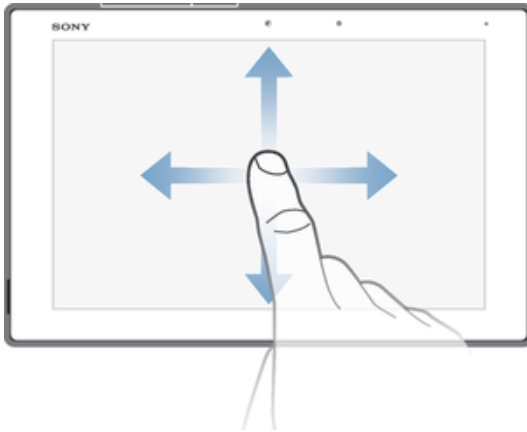

- Scroll up or down a list.
- Scroll left or right, for example, between Home screen panes.

## Flicking

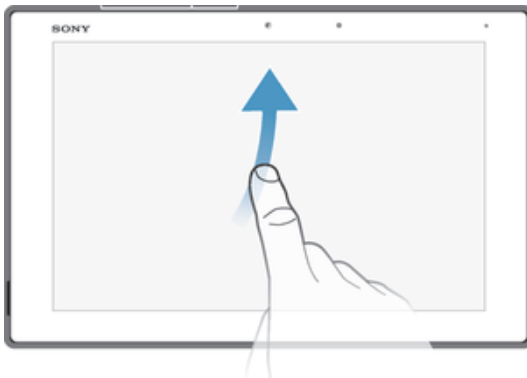

- Scroll quickly, for example, in a list or on a web page. You can stop the scrolling movement by tapping the screen.

## Locking and unlocking the screen

When your device is on and left idle for a set period of time, the screen darkens to save battery power and locks automatically. This lock prevents unwanted actions on the touchscreen when you are not using it. When you buy your device, a basic screen swipe lock is already set. This means that you have to swipe in any direction from the right side of the screen to unlock it. You can change the security settings later and add other kinds of locks. See *Screen lock* on page 36.

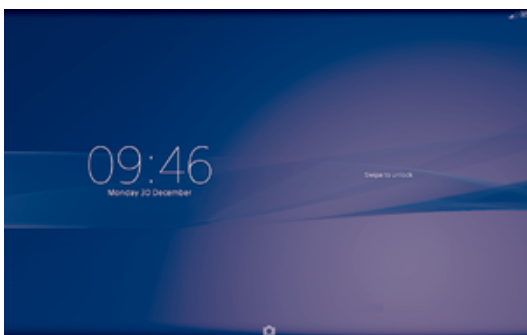

### To activate the screen

- Briefly press the power key .

### To unlock the screen

- Place a finger on the right side of the screen and swipe in any direction.

### To lock the screen

- When the screen is active, briefly press the power key .

## Home screen

The Home screen is the starting point for using your device. It's similar to the desktop on a computer screen. Your Home screen can have up to seven panes, which extend beyond the regular screen display width. The number of Home screen panes is represented by a series of dots at the top of the Home screen. The highlighted dot shows the pane that you are currently in.



### To go to the Home screen

- Press .

### To browse the Home screen



## Home screen panes

You can add new panes to your Home screen (up to a maximum of seven panes) and delete panes. You can also set the pane that you want to use as the main Home screen pane.

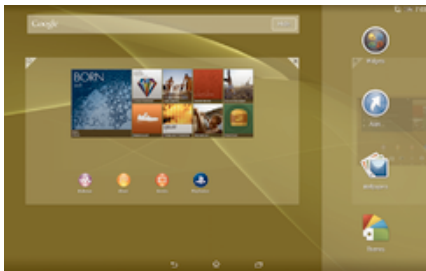

### To set a pane as the main Home screen pane

- 1 Touch and hold an empty area on your Home screen.
- 2 Flick left or right to browse to the pane that you want to set as your main Home screen pane, then tap  at the top corner of the pane.

### To add a pane to your Home screen

- 1 Touch and hold an empty area on your Home screen.
- 2 Flick left or right to browse the panes, then tap .

### To delete a pane from your Home screen

- 1 Touch and hold an empty area on your Home screen.
- 2 Flick left or right to browse to the pane that you want to delete, then tap .

## Application screen

The Application screen, which you open from the Home screen, contains the applications that come pre-installed on your device as well as applications that you download.



### To view all applications on the Application screen

- 1 From your Home screen, tap .
- 2 Flick left or right on the Application screen.

### To open an application from the Application screen

- Flick left or right to find the application, and then tap the application.

### To open the Application screen menu

- When the Application screen is open, drag the left edge of the screen to the right.

### To move an application on the Application screen

- 1 To open the Application screen menu, drag the left edge of the Application screen to the right.
- 2 Make sure that **Own order** is selected under **SHOW APPS**.
- 3 Touch and hold the application until it magnifies, then drag it to the new location.

### To add an application shortcut to the Home screen

- 1 From the Application screen, touch and hold an application icon until the screen vibrates, then drag the icon to the top of the screen. The Home screen opens.
- 2 Drag the icon to the desired location on the Home screen, then release your finger.

### To arrange applications on the Application screen

- 1 To open the Application screen menu, drag the left edge of the Application screen to the right.
- 2 Select the desired option under **SHOW APPS**.

### To search for an application from the Application screen

- 1 To open the Application screen menu, drag the left edge of the Application screen to the right.
- 2 Tap **Search apps**.
- 3 Enter the name of the application that you want to search for.

### To uninstall an application from the Application screen

- 1 To open the Application screen menu, drag the left edge of the Application screen to the right.
- 2 Tap **Uninstall**. All uninstalleable applications are indicated by .
- 3 Tap the application that you want to uninstall, then tap **Uninstall**.

## Navigating applications

You can navigate between applications using the navigation keys, the small apps bar and the recently used applications window, which lets you switch easily between all recently used applications. Some applications are closed when you press  to exit while others continue to run in the background or pause. If the application is paused or runs in the background, you can continue where you left off the next time you open the application.



- 1 Recently used applications window – Open a recently used application
- 2 Small apps bar – Open a small app
- 3 Task navigation key – Open the recently used applications window and the small apps bar
- 4 Home navigation key – Exit an application and go back to the Home screen
- 5 Back navigation key – Go back to the previous screen within an application or close the application

### To open the recently used applications window

- Press .

### To close all the recently used applications

- Tap  and then tap **Close all**.

### To open a menu in an application

- While using the application, press .
- ! A menu is not available in all applications.

## Small apps

You can get quick access to several small apps at any time using the small apps bar. A small app only takes up a small area of your screen, so you can interact with a small app and another application at the same time on the same screen. For example, you can have a webpage open and then open the Calculator small app on top of it and perform calculations. You can download more small apps from Google Play™.





### To open a small app

- 1 To make the small apps bar appear, press .
  - 2 Tap the small app that you want to open.
- 💡 You can open several small apps at the same time.

### To close a small app

- Tap  on the small app window.

### To download a small app

- 1 From the small apps bar, tap , then tap  and tap .
- 2 Search for the small app that you want to download, then follow the instructions to download it and complete the installation.

### To move a small app

- When the small app is open, touch and hold the top left corner of the small app, then move it to the desired location.

### To minimise a small app

- When the small app is open, touch and hold the top left corner of the small app, then drag it to the right edge or to the bottom edge of the screen.
- 💡 To minimise a small app, you can also drag down the status bar to open the Notification panel and then tap .

### To rearrange the small apps in the small apps bar

- Touch and hold a small app and drag it to the desired position.





### To remove a small app from the small apps bar

- Touch and hold a small app, then drag it to .

### To restore a previously removed small app

- 1 Open the small apps bar, then tap .
- 2 Touch and hold the small app that you want to restore, then drag it into the small apps bar.

### To add a widget as a small app

- 1 To make the small apps bar appear, press .
- 2 Tap  >  > .
- 3 Select a widget.
- 4 Enter a name for the widget, if desired, then tap **OK**.

## Widgets

Widgets are small applications that you can use directly on your Home screen. They also function as shortcuts. For example, the Weather widget allows you to see basic weather information directly on your Home screen. But when you tap the widget, the full Weather application opens. You can download additional widgets from Google Play™.



### To add a widget to the Home screen

- 1 Touch and hold an empty area on your Home screen, then tap **Widgets**.
- 2 Find and tap the widget that you want to add.



### To resize a widget

- 1 Touch and hold a widget until it magnifies, then release the widget. If the widget can be resized, for example, the Calendar widget, then a highlighted frame and resizing dots appear.
- 2 Drag the dots inward or outward to shrink or expand the widget.
- 3 To confirm the new size of the widget, tap anywhere on the Home screen.

### To move a widget

- Touch and hold the widget until it magnifies, then drag it to the new location.

### To delete a widget

- Touch and hold the widget until it magnifies, then drag it to ✕.

## Shortcuts and folders

Use shortcuts and folders to manage your applications and keep your Home screen tidy.



- 1 Access an application using a shortcut
- 2 Access a folder containing applications

### To add an application shortcut to your Home screen

- 1 Touch and hold an empty area on your Home screen.
- 2 In the customisation menu, tap **Apps**.
- 3 Scroll through the list of applications and select an application. The selected application gets added to the Home screen.

- 💡 In step 3, alternatively, you can tap Shortcuts and then select an application from the list available. If you use this method to add shortcuts, some of the applications available allow you to add specific functionality to the shortcut.

### To move an item on the Home screen

- Touch and hold the item until it magnifies, then drag the item to the new location.

### To delete an item from the Home screen

- Touch and hold an item until it magnifies, then drag the item to 🗑️.

### To create a folder on the Home screen

- Touch and hold an application icon or a shortcut until it magnifies, then drag and drop it on top of another application icon or shortcut.

### To add items to a folder on the Home screen

- Touch and hold an item until it magnifies, then drag the item to the folder.

### To rename a folder on the Home screen

- 1 Tap the folder to open it.
- 2 Tap the folder's title bar to show the **Folder name** field.
- 3 Enter the new folder name and tap **Done**.

## Background and themes

You can adapt the Home screen to your own style using wallpapers and different themes. You can also change the wallpaper on the lock screen.



### To change your Home screen wallpaper

- 1 Touch and hold an empty area on your Home screen.
- 2 Tap **Wallpapers** and select an option.

### To set a theme

- 1 Touch and hold an empty area on your Home screen.
- 2 Tap **Themes**, then select a theme.

! When you change a theme, the background also changes in some applications.

### To change the wallpaper for the lock screen

- 1 From your Home screen, tap .
- 2 Find and tap **Settings > Personalization > Lock screen**.
- 3 Select an option, then follow the instructions to change your wallpaper.

## Taking a screenshot

You can capture still images of any screen on your device as a screenshot. Screenshots you take are automatically saved in Album.

### To take a screenshot

- 1 Press and hold down the power key and the volume down key simultaneously until you hear a clicking sound.
- 2 To view the screenshot, drag the status bar fully downwards.

## Status and notifications

The icons in the status bar inform you of events such as new messages and calendar notifications, activities in progress such as file downloads, and status information such as battery level and signal strength. You can drag down the status bar to open the Notification panel and handle your notifications.

### To open or close the Notification panel



### To take action on a notification

- Tap the notification.

### To dismiss a notification from the Notification panel

- Place your finger on a notification and flick left or right.

### To clear all notifications from the Notification panel

- Tap **Clear**.

## Notification light









The notification light informs you about battery status and some other events. For example, a flashing white light means there is a new message or a missed call.



## Icons in the status bar

### Status icons

	Signal strength
	No signal
	Roaming
	LTE is available
	GPRS is available
	EDGE is available
	3G is available
	Mobile data network is available
	Sending and downloading LTE data
	Sending and downloading GPRS data
	Sending and downloading EDGE data
	Sending and downloading 3G data
	Sending and downloading mobile data
	Battery status
	The battery is charging
	STAMINA mode is activated
	Low battery mode is activated
	Airplane mode is activated
	The Bluetooth® function is activated
	The SIM card is not inserted

-  The microphone is muted
-  The speakerphone is on
-  Silent mode
-  Vibrate mode
-  An alarm is set
-  GPS is activated
-  Synchronisation is ongoing
-  Problem with sign-in or synchronisation
-  Your device is ready to connect to other ANT+™ capable devices

















! Depending on your service provider, network and/or region, the functions or services represented by some icons in this list may not be available.

### To manage status bar icons

- 1 From your Home screen, tap .
- 2 Find and tap **Settings** > **Personalization**> **Status bar icons**.
- 3 Mark the checkboxes for the system icons that you want to appear in the status bar.

### Notification icons

























The following notification icons may appear on your screen:

-  New email message
-  New text message or multimedia message
-  New voicemail
-  Upcoming calendar event
-  A song is playing
-  The device is connected to a computer via a USB cable
-  Warning message
-  Error message
-  Missed call
-  Call ongoing
-  Call on hold
-  Call forwarding is turned on
-  A Wi-Fi® connection is enabled and wireless networks are available
-  Software updates are available
-  Downloading data
-  Uploading data
-  More (undisplayed) notifications

## To manage notifications

- 1 From your Home screen, tap .
- 2 Find and tap **Settings > Personalization > Manage notifications**.
- 3 Mark the checkboxes for the apps that are allowed to send notifications.

## Application overview

-  Use the Alarm and clock application to set various kinds of alarms.
-  Use your web browser to navigate and view web pages, manage bookmarks, and manage text and images.
-  Use the Calculator application to perform basic calculations.
-  Use the Calendar application to keep track of your events and manage your appointments.
-  Use the camera to take photos and record video clips.
-  Use the Contacts application to manage phone numbers, email address and other information related to your contacts.
-  Access your downloaded applications, documents and pictures.
-  Use the Email application to send and receive emails through both private and corporate accounts.
-  Use the Facebook™ application to engage in social networking with friends, family members and colleagues around the world.
-  Browse and listen to FM radio stations.
-  Use the Album application to view and to work with your photos and videos.
-  Use the Gmail™ application to read, write and organise email messages.
-  Search for information in your device and on the web.
-  View your current location, find other locations, and calculate routes using Google Maps™.
-  Go to Google Play™ to download free and paid applications for your device.
-  Use the Messaging application to send and receive text and multimedia messages.
-  Use the Movies application to play videos in your device and share content with your friends.
-  Use the Walkman® application to organise and play music, audio books and podcasts.
-  View news stories and weather forecasts.
-  Make phone calls by dialling the number manually or by using the smart dial function.
-  Use the Video Unlimited application to rent or purchase videos.
-  Optimise settings to suit your own requirements.
-  Use the Hangouts™ application to chat with friends online.
-  Identify music tracks that you hear playing in your surroundings, and get artist, album and other info.
-  Use YouTube™ to share and view videos from around the world.



Use the Support application to access user support in the device. For example, you can access a User guide, troubleshooting information, plus tips and tricks.



Download and install new applications and updates.

! Some applications are not supported or listed by all networks and/or service providers in all areas.

# Downloading applications

## Downloading applications from Google Play™

Google Play™ is the official online Google store for downloading applications, games, music, movies and books. It includes both free and paid applications. Before you start downloading from Google Play™, make sure that you have a working Internet connection, preferably over Wi-Fi® to limit data traffic charges.

- ! To use Google Play™, you need to have a Google™ account. Google Play™ may not be available in all countries or regions.

### To download an application from Google Play™

- 1 From the Home screen, tap .
- 2 Find and tap **Play Store**.
- 3 Find an item you wish to download by browsing categories, or by using the search function.
- 4 Tap the item to view its details, and follow the instructions to complete the installation.

- ! Some applications may need to access data, settings and various functions on your device in order to work properly. Only install and give permissions to applications that you trust.

- 💡 You can view the permissions granted to a downloaded application by tapping the application under Settings > Apps.

## Downloading applications from other sources

When your device is set to allow downloads from sources other than Google Play™, you can download applications directly from other websites by following the relevant download instructions.

- ! Installing applications of unknown or unreliable origin can damage your device. Only download applications from reliable sources. Contact the application provider if you have any questions or concerns.

### To allow the download of applications from other sources

- 1 From your Home screen, tap .
- 2 Find and tap **Settings** > **Security**.
- 3 Mark the **Unknown sources** checkbox.
- 4 Tap **OK**.

- ! Some applications may need to access data, settings and various functions on your device in order to work properly. Only install and give permissions to applications you trust.



- 💡 You can view the permissions granted to a downloaded application by tapping the application under Settings > Apps.

# Internet and networks

## Browsing the web

The Google Chrome™ web browser for Android™ devices comes pre-installed in most markets. Go to <http://support.google.com/chrome> and click the "Chrome for Mobile" link to get more detailed information about how to use this web browser.

### To browse with Google Chrome™



- 1 From your Home screen, tap .
- 2 Find and tap .
- 3 If you are using Google Chrome™ for the first time, select to either sign in to a Google™ account or browse with Google Chrome™ anonymously.
- 4 Enter a search term or web address in the search and address field, then tap **Go** on the keyboard.

## Internet and MMS settings

To send multimedia messages, or to access the Internet when there is no available Wi-Fi® network, you must have a working mobile data connection with the correct Internet and MMS (Multimedia Messaging Service) settings. Here are some tips:

- For most mobile networks and operators, Internet and MMS settings come pre-installed on your device. You can then start using the Internet and send multimedia messages right away.
  - In some cases, you get the option to download Internet and MMS settings the first time you turn on your device when a SIM card is inserted. It is also possible to download these settings later from the Settings menu.
  - You can manually add, change or delete Internet and MMS settings on your device at any time. If you change or delete an Internet or MMS setting by mistake, download the Internet and MMS settings again.
  - If you cannot access the Internet over a mobile network or if multimedia messaging is not working, even though the Internet and MMS settings have been downloaded successfully to your device, refer to the troubleshooting tips for your device at [www.sonymobile.com/support/](http://www.sonymobile.com/support/) for network coverage, mobile data, and MMS issues.
- ! If STAMINA mode is activated to save power, all mobile data traffic gets paused when the screen is off. If this causes connection problems, try excluding some applications and services from being paused, or deactivate STAMINA mode temporarily. For more information, see *STAMINA mode feature overview* on page 117.

### To download Internet and MMS settings



- 1 From your Home screen, tap .
  - 2 Find and tap **Settings** > **More...** > **Internet settings**.
  - 3 Tap **Accept**. Once the settings have been downloaded successfully,  appears in the status bar and mobile data is turned on automatically.
- ! If the settings cannot be downloaded to your device, check the signal strength of your mobile network. Move to an open location free from obstructions or get close to a window and then try again.

### To check whether mobile data is turned on or off

- 1 From your Home screen, tap .
- 2 Find and tap **Settings** > **More...** > **Mobile networks**.
- 3 Check whether the **Mobile data traffic** checkbox is marked or not.



### To add Internet and MMS settings manually



- 1 From your Home screen, tap .
- 2 Find and tap **Settings** > **More...** > **Mobile networks**.
- 3 Tap **Access Point Names** > **+**.
- 4 Tap **Name** and enter a name as desired.
- 5 Tap **APN** and enter the access point name.
- 6 Enter all other information as required. If you don't know what information is required, contact your network operator for more details.
- 7 When you're done, tap , then tap **Save**.

### To view the downloaded Internet and MMS settings

- 1 From your Home screen, tap .
- 2 Find and tap **Settings** > **More...** > **Mobile networks**.
- 3 Tap **Access Point Names**.
- 4 To view more details, tap any of the available items.

- ! If you have several available connections, the active network connection is indicated by a marked button .

### To delete all Internet and MMS settings



- 1 From your Home screen, tap .
- 2 Find and tap **Settings** > **More...** > **Mobile networks**.
- 3 Tap **Access Point Names**, then tap .
- 4 Tap **Reset to default**. All Internet and MMS settings are deleted.

## Wi-Fi®

Use Wi-Fi® connections to surf the Internet, download applications, or send and receive emails. Once you have connected to a Wi-Fi® network, your device remembers the network and automatically connects to it the next time you come within range.

Some Wi-Fi® networks require you to log in to a web page before you can get access. Contact the relevant Wi-Fi® network administrator for more information.



Available Wi-Fi® networks may be open or secured:

- Open networks are indicated by  next to the Wi-Fi® network name.
  - Secured networks are indicated by  next to the Wi-Fi® network name.
- 💡 Some Wi-Fi® networks do not show up in the list of available networks because they do not broadcast their network name (SSID). If you know the network name, you can add it manually to your list of available Wi-Fi® networks.

### To turn on Wi-Fi®

- 1 From your Home screen, tap .
  - 2 Find and tap **Settings**.
  - 3 Drag the slider beside **Wi-Fi** to the right to turn on the Wi-Fi® function.
- ! It may take a few seconds before Wi-Fi® is enabled.

### To connect to a Wi-Fi® network automatically

- 1 From your Home screen, tap .
  - 2 Find and tap **Settings**.
  - 3 Tap **Wi-Fi**. All available Wi-Fi® networks are displayed.
  - 4 Tap a Wi-Fi® network to connect to it. For secured networks, enter the relevant password.  is displayed in the status bar once you are connected.
- 💡 To search for new available networks, tap , then tap **Scan**. If you cannot connect to a Wi-Fi network successfully, refer to the relevant troubleshooting tips for your device at [www.sonymobile.com/support/](http://www.sonymobile.com/support/).

### To add a Wi-Fi® network manually

- 1 From your Home screen, tap .
  - 2 Find and tap **Settings** > **Wi-Fi**.
  - 3 Tap **+**.
  - 4 Enter the **Network name (SSID)** information.
  - 5 To select a security type, tap the **Security** field.
  - 6 If required, enter a password.
  - 7 To edit some advanced options such as proxy and IP settings, mark the **Show advanced options** checkbox and then edit as desired.
  - 8 Tap **Save**.
- ! Contact your Wi-Fi® network administrator to get the network SSID and password.

### Increasing Wi-Fi® signal strength

There are a number of things you can do to increase the strength of a Wi-Fi® signal:

- Move your device closer to the Wi-Fi® access point.
- Move the Wi-Fi® access point away from any potential obstructions or interference.
- Don't cover the Wi-Fi® antenna area of your device (the highlighted area in the illustration).





- ! FCC Caution: Operation in the 5.15 GHz to 5.25 GHz frequency band is only permitted for indoor use. For indoor and outdoor operation, connect your device to an FCC approved 5 GHz WLAN access point.

### Wi-Fi® settings

When you are connected to a Wi-Fi® network or when there are Wi-Fi® networks available in your vicinity, it is possible to view the status of these networks. You can also enable your device to notify you whenever an open Wi-Fi® network is detected.

If you are not connected to a Wi-Fi® network, your device uses a mobile data connection to access the Internet (if you have set up and enabled a mobile data connection on your device). By adding a Wi-Fi® sleep policy, you can specify when to switch from Wi-Fi® to mobile data.



### To enable Wi-Fi® network notifications

- 1 Turn on Wi-Fi®, if it is not already on.
- 2 From your Home screen, tap .
- 3 Find and tap **Settings** > **Wi-Fi**.
- 4 Press .
- 5 Tap **Advanced**.
- 6 Mark the **Network notification** checkbox.

### To view detailed information about a connected Wi-Fi® network

- 1 From the Home screen, tap .
- 2 Find and tap **Settings** > **Wi-Fi**.
- 3 Tap the Wi-Fi® network that you are currently connected to. Detailed network information is displayed.

### To add a Wi-Fi® sleep policy



- 1 From the Home screen, tap .
- 2 Find and tap **Settings** > **Wi-Fi**.
- 3 Press .
- 4 Tap **Advanced**.
- 5 Tap **Keep Wi-Fi on during sleep**.
- 6 Select an option.

## Sharing your mobile data connection



You can share your mobile data connection with other devices in several ways:

- USB tethering – share your mobile data connection with a single computer using a USB cable.
- Bluetooth® tethering – share your mobile data connection with up to five other devices via Bluetooth®.
- Portable Wi-Fi® hotspot – share your mobile data connection simultaneously with up to 10 other devices, including devices that support WPS technology.



### To share your data connection using a USB cable

- 1 Deactivate all USB cable connections to your device.
  - 2 Using the USB cable that came with your device, connect your device to a computer.
  - 3 From your Home screen, tap .
  - 4 Find and tap **Settings** > **More...** > **Tethering & portable hotspot**.
  - 5 Mark the **USB tethering** checkbox, then tap **OK** if prompted.  is displayed in the status bar once you are connected.
  - 6 To stop sharing your data connection, unmark the **USB tethering** checkbox or disconnect the USB cable.
-  You cannot share your device's data connection and SD card over a USB cable at the same time.



### To share your mobile data connection with another Bluetooth® device

- 1 Make sure that your device and the Bluetooth® device are paired with each other.
  - 2 Your device: Turn on mobile data, then mark the **Bluetooth tethering** checkbox under **Settings** > **More...** > **Tethering & portable hotspot**.
  - 3 Bluetooth® device: Set up the device so that it obtains its network connection using Bluetooth®. If the device is a computer, refer to the relevant instructions to complete the setup. If the device runs on the Android™ operating system, tap the settings icon beside the name of the device that it is paired with under **Settings** > **Bluetooth** > **Paired devices**, then mark the **Internet access** checkbox.
  - 4 Your device: Wait for  to appear in the status bar. Once it appears, the setup is complete.
  - 5 To stop sharing your mobile data connection, unmark the **Bluetooth tethering** checkbox.
-  The Bluetooth tethering checkbox becomes unmarked every time you turn off your device or turn off the Bluetooth® function.
-  For more information about pairing and turning on mobile data, see *To pair your device with another Bluetooth® device* on page 100 and *To turn mobile data traffic on or off* on page 29.

### To use your device as a portable Wi-Fi® hotspot

- 1 From your Home screen, tap .
- 2 Find and tap **Settings > More... > Tethering & portable hotspot**.
- 3 Tap **Portable Wi-Fi hotspot settings > Configure Wi-Fi hotspot**.
- 4 Enter the **Network name (SSID)** information.
- 5 To select a security type, tap the **Security** field. If required, enter a password.
- 6 Tap **Save**.
- 7 Tap  and mark the **Portable Wi-Fi hotspot** checkbox.
- 8 If prompted, tap **OK** to confirm.  appears in the status bar once the portable Wi-Fi® hotspot is active.
- 9 To stop sharing your data connection via Wi-Fi®, unmark the **Portable Wi-Fi hotspot** checkbox.

### To allow a WPS-supported device to use your mobile data connection

- 1 Make sure that your device is functioning as a portable Wi-Fi® hotspot.
- 2 From your Home screen, tap .
- 3 Find and tap **Settings > More... > Tethering & portable hotspot > Portable Wi-Fi hotspot settings**.
- 4 Make sure that the **Discoverable** checkbox is marked.
- 5 Under **Configure Wi-Fi hotspot**, make sure that your portable hotspot is secured by a password.
- 6 Tap **WPS Push Button**, then follow the relevant instructions. Alternatively, tap  > **WPS PIN Entry**, then enter the PIN that appears on the WPS-supported device.

### To rename or secure your portable hotspot



- 1 From the Home screen, tap .
- 2 Find and tap **Settings > More... > Tethering & portable hotspot**.
- 3 Tap **Portable Wi-Fi hotspot settings > Configure Wi-Fi hotspot**.
- 4 Enter the **Network name (SSID)** for the network.
- 5 To select a security type, tap the **Security** field.
- 6 If required, enter a password.
- 7 Tap **Save**.

## Tethering with Xperia Link™

If you have an Xperia™ mobile phone, you can share the phone's mobile data connection with your Xperia™ tablet. This way, your tablet can connect to the Internet without having to use its own SIM card and data connection. This feature is useful when you are out and about and don't have a mobile or Wi-Fi® connection on your tablet. Before you use tethering with Xperia Link™, make sure the Xperia Link™ application is installed and set up on both devices. Also, your Xperia™ phone must have a camera with auto focus.

- ! The Xperia Link™ application is only supported by Xperia™ phones running the Android™ 4.0 software version or higher. If the Xperia Link™ application is not pre-installed on your Xperia™ phone, you can download it from Google Play™.

### To connect your tablet with an Xperia™ phone using Xperia Link™

- 1 Make sure the Bluetooth function is activated on both your Xperia™ phone and tablet and that the phone has an active mobile data connection.
- 2 Tablet: From your Home screen, tap  > **Xperia Link > Setup**, then follow the instructions to complete the setup. A QR code™ appears on the screen.
- 3 Phone: From your Home screen, tap  > **Xperia Link > Setup > Scan**.
- 4 Hold your phone over the QR code™ on the tablet screen until the complete QR code™ is visible in the viewfinder of the phone.
- 5 Your tablet automatically scans the QR code™ and connects to your Xperia™ phone once the QR code™ is recognised.
- 6 To confirm the connection, tap **OK**.

## Controlling data usage

You can keep track of the amount of data transferred to and from your device over your mobile data or Wi-Fi® connection during a given period. For example, you can view the amount of data used by individual applications. For data transferred over your mobile data connection, you can also set data usage warnings and limits to avoid additional charges.

- ! Adjusting data usage settings can help you keep greater control over data usage but cannot guarantee the prevention of additional charges.

### To turn mobile data traffic on or off

- 1 From your Home screen, tap .
- 2 Find and tap **Settings** > **Data usage**.
- 3 Drag the slider beside **Mobile data traffic** accordingly to turn mobile data traffic on or off.

- 💡 When mobile data traffic is turned off, your device can still establish Wi-Fi® and Bluetooth® connections.

### To set a data usage warning

- 1 Make sure that mobile data traffic is turned on.
- 2 From your Home screen, tap .
- 3 Find and tap **Settings** > **Data usage**.
- 4 To set the warning level, drag the warning line to the desired value. You receive a warning notification when the amount of data traffic approaches the level you set.

### To set a mobile data usage limit

- 1 Make sure that mobile data traffic is turned on.
- 2 From your Home screen, tap .
- 3 Find and tap **Settings** > **Data usage**.
- 4 Mark the **Set mobile data limit** checkbox if it is not marked, then tap **OK**.
- 5 To set the mobile data usage limit, drag the corresponding line to the desired value.



- ! Once your mobile data usage reaches the set limit, mobile data traffic on your device gets turned off automatically.

### To control the mobile data usage of individual applications

- 1 From your Home screen, tap .
- 2 Find and tap **Settings** > **Data usage**.
- 3 Find and tap the desired application.
- 4 Mark the **Restrict background data** checkbox.
- 5 To access more specific settings for the application (if available), tap **View app settings** and make the desired changes.

- 💡 The performance of individual applications may be affected if you change the related data usage settings.

### To view data transferred via Wi-Fi®

- 1 From your Home screen, tap .
- 2 Find and tap **Settings** > **Data usage**.
- 3 Tap , then mark the **Show Wi-Fi usage** checkbox if it is not marked.
- 4 Tap the **Wi-Fi** tab.

## Selecting mobile networks

Your device automatically switches between mobile networks depending on which mobile networks are available where you are. You can also manually set your device to use a particular mobile network mode, for example, WCDMA or GSM.

Different status icons are displayed in the status bar depending on the type or mode of network that you are connected to. Refer to *Status icons* on page 19 to see what the different status icons look like.

#### To select a network mode

- 1 From your Home screen, tap .
- 2 Find and tap **Settings** > **More...** > **Mobile networks**.
- 3 Tap **Network Mode**.
- 4 Select a network mode.

#### To select another network manually

- 1 From your Home screen, tap .
- 2 Find and tap **Settings** > **More...** > **Mobile networks** > **Service providers**.
- 3 Tap **Search mode** > **Manual**.
- 4 Select a network.

- ! If you select a network manually, your device will not search for other networks, even if you move out of range of the manually selected network.

#### To activate automatic network selection

- 1 From your Home screen, tap .
- 2 Find and tap **Settings** > **More...** > **Mobile networks** > **Service providers**.
- 3 Tap **Search mode** > **Automatic**.

## Virtual private networks (VPNs)

Use your device to connect to virtual private networks (VPNs), which allow you to access resources inside a secured local network from a public network. For example, VPN connections are commonly used by corporations and educational institutions for users who need to access intranets and other internal services when they are outside of the internal network, for example, when they are travelling.

VPN connections can be set up in many ways, depending on the network. Some networks may require you to transfer and install a security certificate on your device. For detailed information on how to set up a connection to your virtual private network, please contact the network administrator of your company or organisation.

#### To add a virtual private network

- 1 From your Home screen, tap .
- 2 Find and tap **Settings** > **More...** > **VPN**.
- 3 Tap **+**.
- 4 Select the type of VPN to add.
- 5 Enter your VPN settings.
- 6 Tap **Save**.

#### To connect to a virtual private network

- 1 From your Home screen, tap .
- 2 Find and tap **Settings** > **More...** > **VPN**.
- 3 In the list of available networks, tap the VPN that you want to connect to.
- 4 Enter the required information.
- 5 Tap **Connect**.

#### To disconnect from a virtual private network

- 1 Drag the status bar downwards.
- 2 Tap the notification for the VPN connection to turn it off.

# Synchronising data on your device

## Synchronising with online accounts

Synchronise your device with contacts, email, calendar events and other information from online accounts, for example, email accounts such as Gmail™ and Exchange ActiveSync, Facebook™, Flickr™ and Twitter™. You can synchronise data automatically for all accounts by activating the auto-sync function. Or you can synchronise each account manually.



### To set up an online account for synchronisation

- 1 From your Home screen, tap .
- 2 Tap **Settings** > **Add account**, then select the account that you want to add.
- 3 Follow the instructions to create an account, or sign in if you already have an account.



### To activate the auto-sync function

- 1 From your Home screen, tap  > **Settings**.
- 2 Drag the slider beside **Auto-sync** to the right.

### To synchronise manually with an online account

- 1 From your Home screen, tap  > **Settings**.
- 2 Under **Accounts**, select the account type, then tap the name of the account that you want to synchronise with. A list of items that can be synchronised with the account appears.
- 3 Mark the items that you want to synchronise.
- 4 Tap , then tap **Sync now**.

### To remove an online account

- 1 From your Home screen, tap  > **Settings**.
- 2 Under **Accounts**, select the account type, then tap the name of the account that you want to remove.
- 3 Tap , then tap **Remove account**.
- 4 Tap **Remove account** again to confirm.

## Synchronising with Microsoft® Exchange ActiveSync®



Using a Microsoft Exchange ActiveSync account, you can access your corporate email messages, calendar appointments and contacts directly on your device. After setup, you can find your information in the **Email**, **Calendar** and **Contacts** applications.





### To set up an EAS account for synchronisation

- 1 Make sure that you have your domain and server details, provided by your corporate network administrator, available.
  - 2 From your Home screen, tap .
  - 3 Tap **Settings** > **Add account** > **Exchange ActiveSync**.
  - 4 Enter your corporate email address and password.
  - 5 Tap **Next**. Your device begins to retrieve your account information. If a failure occurs, enter the domain and server details for your account manually and then tap **Next**.
  - 6 Tap **OK** to allow your corporate server to control your device.
  - 7 Select what data you want to sync with your device, such as contacts and calendar entries.
  - 8 If desired, activate the device administrator to allow your corporate server to control certain security features on your device. For example, you can allow your corporate server to set password rules and set storage encryption.
  - 9 When the setup is done, enter a name for the corporate account.
- ! When you change the login password for an EAS account on your computer, you have to log in again to the EAS account on your device.



### To change the settings of an EAS account

- 1 From your Home screen, tap .
- 2 Tap **Email**, then tap .
- 3 Tap **Settings** and select an EAS account, then change the settings of the EAS account as desired.

### To set a synchronisation interval for an EAS account

- 1 From your Home screen, tap .
- 2 Tap **Email**, then tap .
- 3 Tap **Settings** and select an EAS account.
- 4 Tap **Check frequency** > **Check frequency** and select an interval option.

### To remove an EAS account

- 1 From your Home screen, tap  > **Settings**.
- 2 Under **Accounts**, tap **Exchange ActiveSync**, then select the EAS account that you want to remove.
- 3 Tap , then tap **Remove account**.
- 4 Tap **Remove account** again to confirm.

## Synchronising with Outlook® using a computer

You can use the Calendar and Contacts applications within the PC Companion and the Sony Bridge for Mac computer programs to synchronise your device with the calendar and contacts from your Outlook account.

- 💡 For more information on how to install the PC Companion on a PC or the Sony Bridge for Mac application on an Apple® Mac® computer, see *Computer tools* on page 112.

### To synchronise with your Outlook contacts using a computer

- 1 Make sure that the PC Companion application is installed on the PC or the Sony Bridge for Mac application is installed on the Apple® Mac® computer.
- 2 Computer: Open the PC Companion application or the Sony Bridge for Mac application.
- 3 Click **Start** to start the *Contacts* and *Contacts Sync* applications and follow the on-screen instructions to synchronise your device with your Outlook contacts.



### To synchronise with your Outlook calendar using a computer

- 1 Make sure that the PC Companion application is installed on the PC or the Sony Bridge for Mac application is installed on the Apple® Mac® computer.
- 2 Computer: Open the PC Companion application or the Sony Bridge for Mac application.
- 3 Click **Start** to start the *Calendar* and *Calendar Sync* applications and follow the on-screen instructions to synchronise your device with your Outlook calendar.

# Basic settings

## Accessing settings

View and change settings for your device from the Settings menu. The Settings menu is accessible from both the Application screen and the Quick settings panel.

### To open the device settings menu from the Application screen

- 1 From your Home screen, tap .
- 2 Tap **Settings**.

### To view information about your device

- 1 From your Home screen, tap .
- 2 Find and tap **Settings** > **About tablet**.

### To activate the screen using Tap to wake up mode

- 1 Make sure that Tap to wake up mode is turned on. To turn it on, tap **Settings** > **Display**, then mark the **Tap to wake up** checkbox.
- 2 Double-tap the screen.

### To open the Quick settings panel

- Drag the right side of the status bar downwards.

### To select which settings to display on the Quick settings panel

- 1 Drag the right side of the status bar downwards, then tap **Edit**.
- 2 Touch and hold an icon, then drag and drop to the Quick settings panel for display.

### To rearrange the Quick settings panel

- 1 Drag the right side of the status bar downwards, then tap **Edit**.
- 2 Touch and hold an icon, then move it to the desired position.

## Sound, ringtone and volume

You can adjust the ringtone volume for incoming calls and notifications as well as for music and video playback. You can also set your device to silent mode so that it doesn't ring when you're in a meeting.

### To adjust the ringtone volume with the volume key

- Press the volume key up or down.



### To adjust the media playing volume with the volume key

- When playing music or watching video, press the volume key up or down.

### To set your device to vibrate mode

- Press the volume key down until  appears in the status bar.



### To set your device to silent mode

- 1 Press the volume key down until the device vibrates and  appears in the status bar.
- 2 Press the volume key down again.  appears in the status bar.



### To set your device to vibrate and ring mode

- 1 From your Home screen, tap .
- 2 Find and tap **Settings** > **Sound**.
- 3 Mark the **Vibrate when ringing** checkbox.

### To set a ringtone

- 1 From your Home screen, tap .
- 2 Find and tap **Settings > Sound > Phone ringtone**.
- 3 Select an option from the list or tap  to select a music file saved to your device.
- 4 To confirm, tap **Done**.

### To select the notification sound

- 1 From your Home screen, tap .
- 2 Find and tap **Settings > Sound > Notification sound**.
- 3 Select an option from the list or tap  to select a music file saved to your device.
- 4 Tap **Done**.

### To enable touch tones

- 1 From your Home screen, tap .
- 2 Find and tap **Settings > Sound**.
- 3 Mark the **Dialpad touch tones** and **Touch sounds** checkboxes.

## SIM card protection

You can lock and unlock each SIM card that you use in your device with a PIN (Personal Identity Number). When a SIM card is locked, the subscription linked to the card is protected against misuse, meaning that you have to enter a PIN every time you start your device.

If you enter the PIN incorrectly more times than the maximum number of attempts allowed, your SIM card will become blocked. You then need to enter your PUK (Personal Unblocking Key) and a new PIN. Your PIN and PUK are supplied by your network operator.

### To set up a SIM card lock

- 1 From the Home screen, tap .
  - 2 Find and tap **Settings > Security > Set up SIM card lock**.
  - 3 Mark the **Lock SIM card** checkbox.
  - 4 Enter the SIM card PIN and tap **OK**.
- ! The SIM card lock is now active and you will be prompted to enter this lock every time you restart the device.



### To remove a SIM card lock

- 1 From the Home screen, tap .
- 2 Find and tap **Settings > Security > Set up SIM card lock**.
- 3 Unmark the **Lock SIM card** checkbox.
- 4 Enter the SIM card PIN and tap **OK**.

### To change the SIM card PIN

- 1 From the Home screen, tap .
- 2 Find and tap **Settings > Security > Set up SIM card lock**.
- 3 Tap **Change SIM PIN**.
- 4 Enter the old SIM card PIN and tap **OK**.
- 5 Enter the new SIM card PIN and tap **OK**.
- 6 Re-type the new SIM card PIN and tap **OK**.

### To unlock a blocked SIM card using the PUK code

- 1 Enter the PUK code and tap .
- 2 Enter a new PIN code and tap .
- 3 Re-enter the new PIN code and tap .

! If you enter an incorrect PUK code too many times, you need to contact your network operator to get a new SIM card.

## Screen settings

### To adjust the screen brightness

- 1 From your Home screen, tap .
- 2 Find and tap **Settings** > **Display** > **Brightness**.
- 3 Unmark the **Adapt to lighting conditions** checkbox if it is marked.
- 4 Drag the slider to adjust the brightness.

 Lowering the brightness level increases battery performance.

### To set the screen to vibrate on touch

- 1 From your Home screen, tap .
- 2 Find and tap **Settings** > **Sound**.
- 3 Mark the **Vibrate on touch** checkbox. The screen now vibrates when you tap soft keys and certain applications.

### To adjust the idle time before the screen turns off

- 1 From your Home screen, tap .
- 2 Find and tap **Settings** > **Display** > **Sleep**.
- 3 Select an option.

 To turn off the screen quickly, briefly press the power key .

## Screen lock

There are several ways to lock the screen. The security level of each lock type is listed below in order of weakest to strongest:

- Swipe – no protection, but you have quick access to the Home screen
- Bluetooth Unlock – unlocks your device by using paired Bluetooth devices
- Face Unlock – unlocks your device when you look at it
- Unlock pattern – draw a simple pattern with your finger to unlock your device
- Unlock PIN – enter a numeric PIN of at least four digits to unlock your device
- Unlock password – enter an alpha-numeric password to unlock your device

! It is very important that you remember your screen unlock pattern, PIN or password. If you forget this information, it may not be possible to restore important data such as contacts and messages.

### To change screen lock type

- 1 From your Home screen, tap .
- 2 Find and tap **Settings** > **Security** > **Screen lock**.
- 3 Follow the instructions in your device and select another screen lock type.

### To unlock the screen using the Bluetooth® unlock feature

! Make sure that your device and other Bluetooth® devices are paired before you use the Bluetooth® unlock feature. For more information about pairing, see *To pair your device with another Bluetooth® device* on page 100.

- 1 From your Home screen, tap , then find and tap **Settings > Security**.
  - 2 Tap **Screen lock > Bluetooth unlock**.
  - 3 Tap **Continue** and select the device that you want to use to unlock the screen, then tap **Continue**.
  - 4 Choose an option as the backup lock to unlock the screen when no Bluetooth® devices are connected.
  - 5 In other Bluetooth® devices, find and tap the name of your device under **Settings > Bluetooth > Paired devices**. When **Connected** appears on the Bluetooth® devices, press the power key on your device immediately.
- ! If your device is disconnected from other Bluetooth® devices, you need to unlock the screen using a PIN or a Pattern.

#### To set up the Face Unlock feature

- 1 From your Home screen, tap  > **Settings > Security > Screen lock**.
  - 2 Tap **Face Unlock**, then follow the instructions in your device to capture a photo of your face.
  - 3 After your face is successfully captured, tap **Continue**.
  - 4 Select a backup unlock method and follow the instructions in the device to complete the setup.
- 💡 For best results, capture your face in an indoor area that is well lit but not too bright, and hold the device at eye level.

#### To unlock the screen using the Face Unlock feature

- 1 Activate the screen.
  - 2 Look at your device from the same angle you used to capture your Face Unlock photo.
- 💡 If the Face Unlock feature fails to recognise your face, you must use the backup unlock method to unlock the screen.



#### To create a screen lock pattern

- 1 From your Home screen, tap .
  - 2 Find and tap **Settings > Security > Screen lock > Pattern**.
  - 3 Follow the instructions in your device.
- ! If the unlock pattern you draw on the screen is rejected five times in a row, you can select to either wait 30 seconds and then try again, or, if you have a Google account set up on your device, enter your account information (password and username) to unlock the device.



#### To change the screen lock pattern

- 1 From your Home screen, tap .
- 2 Find and tap **Settings > Security > Screen lock**.
- 3 Draw your screen unlock pattern.
- 4 Tap **Pattern** and follow the instructions in your device.

#### To create a screen unlock PIN

- 1 From your Home screen, tap  > **Settings > Security > Screen lock > PIN**.
- 2 Enter a numeric PIN.
- 3 If necessary, tap  to minimise the keyboard.
- 4 Tap **Continue**.
- 5 Re-enter and confirm your PIN.
- 6 If necessary, tap  to minimise the keyboard.
- 7 Tap **OK**.

### To create a screen lock password

- 1 From your Home screen, tap  > **Settings** > **Security** > **Screen lock** > **Password**.
- 2 Enter a password.
- 3 If necessary, tap  to minimise the keyboard.
- 4 Tap **Continue**.
- 5 Re-enter and confirm your password.
- 6 If necessary, tap  to minimise the keyboard.
- 7 Tap **OK**.





### To view notifications from the lock screen

- 1 From the lock screen, drag the left side of the status bar downwards.
  - 2 Tap the notification that you want to view.
-  You can only view notifications from the lock screen when you lock your screen with the Swipe mode.

## Language settings

You can select a default language for your device and change it again at a later time. You can also change the writing language for text input. See *Personalising the Xperia keyboard* on page 43.

### To change the language

- 1 From the Home screen, tap .
  - 2 Find and tap **Settings** > **Language & input** > **Language**.
  - 3 Select an option.
  - 4 Tap **OK**.
-  If you select the wrong language and cannot read the menu texts, find and tap . Then select the text beside  and select the first entry in the menu that opens. You can then select the language you want.

## Date and time

You can change the date and time on your device.

### To set the date manually

- 1 From the Home screen, tap .
- 2 Find and tap **Settings** > **Date & time**.
- 3 Unmark the **Automatic date & time** checkbox, if it is marked.
- 4 Tap **Set date**.
- 5 Adjust the date by scrolling up and down.
- 6 Tap **Set**.

### To set the time manually

- 1 From your Home screen, tap .
- 2 Find and tap **Settings** > **Date & time**.
- 3 Unmark the **Automatic date & time** checkbox if it is marked.
- 4 Tap **Set time**.
- 5 Scroll up or down to adjust the hour and minute.
- 6 If applicable, scroll up to change **AM** to **PM**, or vice versa.
- 7 Tap **Set**.

### To set the time zone

- 1 From your Home screen, tap .
- 2 Find and tap **Settings** > **Date & time**.
- 3 Tap **Select time zone**.
- 4 Select an option.

## X-Reality™ for mobile

Sony's X-Reality™ for mobile technology improves the viewing quality of photos and videos after you take them, giving you clearer, sharper and more natural images. X-Reality™ for mobile is turned on by default, but you can turn it off if you want to reduce battery consumption.

### To turn on X-Reality™ for mobile

- 1 From your Home screen, tap .
- 2 Find and tap **Settings** > **Display** > **Image enhancement**.
- 3 Tap the **X-Reality for mobile** radio button if it is not already selected.

## Super-vivid mode

Sony's super-vivid mode intensifies and saturates the colours for images to increase the sharpness and contrast.

### To turn on Super-vivid mode

- 1 From your Home screen, tap .
- 2 Find and tap **Settings** > **Display** > **Image enhancement**.
- 3 Tap the **Super-vivid mode** radio button if it is not already selected.

## Enhancing the sound output

You can enhance the sound of your device by manually enabling individual sound settings such as Equaliser and Surround sound. You can also enable the Dynamic normaliser to minimise volume differences between songs or videos. And you can listen to high-resolution audio using a regular headset (connected via the headset socket) or by connecting your device with a digital-to-analogue converter/amplifier (DAC/amp) by cable via the micro USB port of your device.

### To enhance the sound output manually

- 1 From your Home screen, tap .
- 2 Find and tap **Settings** > **Sound** > **Audio settings**.
- 3 Mark the **ClearAudio+** checkbox.

### To adjust the sound settings manually

- 1 From the Home screen, tap .
- 2 Find and tap **Settings** > **Sound** > **Audio settings**.
- 3 Unmark the **ClearAudio+** checkbox if it is marked.
- 4 Tap **Sound effects**.
- 5 Adjust the sound settings by dragging the frequency band buttons up or down.

- 💡 The manual adjustment of sound output settings has no effect on voice communication applications. For example, there is no change in the voice call sound quality.

### To minimise volume differences using the Dynamic normaliser

- 1 From the Home screen, tap .
- 2 Find and tap **Settings** > **Sound** > **Audio settings**.
- 3 Mark the **Dynamic normalizer** checkbox.

## High-resolution audio

There are different ways to listen to your music and videos in high-resolution audio:

- Connect a headset to your device using the regular headset socket.
- Use the micro USB port with a supported cable to output the sound to a high-resolution digital-to-analogue converter/amplifier (DAC/amp) and then connect your headphones or speakers to it. For example, you can use the Sony PHA-2 Portable Hi-

Res DAC/Headphone Amplifier or the Sony MAP-S1 High-Resolution Audio Stereo Amplifier to get a much higher quality sound.

- Use the micro USB port with a supported cable to output the sound to a digital-to-analogue converter/amplifier (DAC/amp) and then connect this device to a home sound system (via the system's amplifier).
- Stream the sound (via micro USB cable) from your device to an all-in-one high-resolution DAC amplifier/speaker system such as the Sony SRS-X9 Ultra Premium Hi-Res Speaker.

#### To play high-resolution audio using a headset only

- 1 Connect the headset to your device via the headset socket.
  - 2 Using the relevant application in your device, play the audio file that you want to listen to in high-resolution.
- 💡 Sound outputted via the headset socket/jack is by default in high resolution and no changes to settings are necessary. A digital-to-analogue converter in the device converts the sound to analogue format.

#### To play high-resolution audio via the micro USB port

- 1 From the Home screen, tap .
- 2 Find and tap **Settings > Sound > Audio settings**.
- 3 Mark the **Hi-Res Audio via USB** checkbox.
- 4 Using a USB cable, connect your device to one of the following device types:
  - a portable digital-to-analogue converter/amplifier (DAC/amp) device, for example, the Sony PHA-2 Portable Hi-Res DAC/Headphone Amplifier.
  - the high-resolution player/amplifier unit (DAC/amp) of a home entertainment/sound system, for example, the Sony MAP-S1.
- 5 Make sure the amplifier is connected to a set of speakers or headphones.
- 6 Using the relevant application in your device, play the audio or video file that you want to listen to in high-resolution.

## Noise cancellation

Your device supports noise cancelling headsets. By using a noise cancelling headset with your device, you can get much clearer audio quality when listening, for example, to music in a noisy environment, such as on a bus, a train or a plane. You can also use this feature to create a silent environment in which to study, work or read.

- 💡 To ensure optimal performance, noise cancelling headsets from Sony are recommended.

#### To use a noise cancelling headset

- 1 Connect the noise cancelling headset to your device.
- 2 From your Home screen, tap  > **Settings > Sound > Audio settings > Noise canceling**, then drag the slider beside **Noise canceling** to the right.
- 3 If you want **Noise canceling** to be enabled only during music or video playback or when the screen is active, mark the **Power save mode** checkbox.
- 4 If you want **Noise canceling** to be enabled for as long as the headset is connected, unmark the **Power save mode** checkbox.

- ! A noise cancelling headset may not be included with your device at purchase.

- 💡 When a noise cancelling headset is connected to your device for the first time, you can also select the noise cancelling headset type by dragging down the status bar to open the Notification panel and then tapping Headphones connected.

#### To adjust the settings to the noise environment

- 1 Make sure a noise cancelling headset is connected to your device.
- 2 From your Home screen, tap .
- 3 Find and tap **Settings > Sound > Audio settings > Noise canceling > Noise environment**.
- 4 Select the relevant noise environment type, then tap **OK**.



# Typing text

## On-screen keyboard

You can enter text with the on-screen QWERTY keyboard by tapping each letter individually, or you can use the Gesture input feature and slide your finger from letter to letter to form words. If you prefer to use a smaller version of the on-screen keyboard and enter text using only one hand, you can activate the split keyboard or mini keyboard instead.

You can select up to three languages for text input. The keyboard detects the language that you are using and predicts the words for that language as you type.



- 1 Delete a character before the cursor.
- 2 Enter a carriage return or confirm text input.
- 3 Switch between lower-case ⇧, upper-case ⇧ and caps ⇧. For some languages, this key is used to access extra characters in the language.
- 4 Shift to the moveable split keyboard or mini keyboard
- 5 Enter a space.
- 6 Personalise your keyboard. This key disappears after the keyboard is personalised.
- 7 Display numbers and symbols. For even more symbols, tap +=.\$.

### To display the on-screen keyboard to enter text

- Tap a text entry field.





### To enter text character by character

- 1 To enter a character visible on the keyboard, tap the character.
- 2 To enter a character variant, touch and hold a regular keyboard character to get a list of available options, then select from the list. For example, to enter "é", touch and hold "e" until other options appear, then, while keeping your finger pressed on the keyboard, drag to and select "é".

### To enter a period

- After you enter a word, double-tap the space bar.



### To switch between the full keyboard and the small keyboards

- 1 When you enter text using the on-screen keyboard, tap ,  or .
  - 2 Select a keyboard option.
- 💡 Drag  to move the small keyboard as desired.

### To enter text using the Gesture input function

- 1 When the on-screen keyboard is displayed, slide your finger from letter to letter to trace the word that you want to write.
- 2 After you finish entering a word, lift up your finger. A word suggestion appears based on the letters that you have traced.
- 3 If the word that you want does not appear, tap  to see other options and select accordingly. If the desired option does not appear, delete the entire word and trace it again, or enter the word by tapping each letter individually.





### To change the Gesture input settings

- 1 When the on-screen keyboard is displayed, tap .
- 2 Tap , then tap **Keyboard settings**.
- 3 To activate or deactivate the Gesture input function, mark or unmark the **Gesture input** checkbox.



## Entering text using voice input

When you enter text, you can use the voice input function instead of typing the words. Just speak the words that you want to enter. Voice input is an experimental technology from Google™, and is available for a number of languages and regions. You must enable voice input before you can start using it.

### To enable voice input

- 1 When you enter text using the on-screen keyboard, drag the status bar downwards to open the Notification panel, then tap .
- 2 Tap **Set up input methods**, then mark the **Google voice typing** checkbox.
- 3 On the on-screen keyboard, tap  > , then tap **Keyboard settings**.
- 4 Mark the checkbox beside **Google voice typing key**.
- 5 To save your settings, tap . A microphone icon  now appears on your on-screen keyboard.

### To enter text using voice input

- 1 Open the on-screen keyboard.
- 2 Tap . When  appears, speak to enter text.
- 3 When you're finished, tap  again. The suggested text appears.
- 4 Edit the text manually if necessary.

- 💡 To make the keyboard appear and enter text manually, tap .

## Editing text

You can select, cut, copy and paste text as you write. You can access the editing tools by double-tapping the entered text. The editing tools then become available via an application bar.

### Application bar



- 1 Close the application bar
- 2 Select all text
- 3 Cut text
- 4 Copy text

- !  only appears when you have text saved on the clipboard.

### To select text

- 1 Enter some text, then double-tap the text. The word you tap gets highlighted by tabs on both sides.
- 2 Drag the tabs left or right to select more text.



### To edit text

- 1 Enter some text, then double-tap the entered text to make the application bar appear.
- 2 Select the text that you want to edit, then use the tools in the application bar to make your desired changes.

## Personalising the Xperia keyboard

When entering text using the on-screen keyboard, you can access keyboard and other text input settings that help you, for example, to set options for writing languages, text prediction and correction, automatic spacing, and quick full stops. The keyboard can use data from messaging and other applications to learn your writing style. There is also a Personalisation guide that runs you through the most basic settings, to get you started quickly.

### To access the on-screen keyboard settings



- 1 When you enter text using the on-screen keyboard, tap .
- 2 Tap , then tap **Keyboard settings** and change the settings as desired.
- 3 To add a writing language for text input, tap **Writing languages** and mark the relevant checkboxes.
- 4 Tap **OK** to confirm.

### To use your writing style

- 1 When you enter text using the on-screen keyboard, tap .
- 2 Tap , then tap **Keyboard settings** > **Use my writing style** and select a source.

### To select a keyboard layout variant

- ! Layout variants are only available for the on-screen keyboard when you select two or three writing languages and may not be available in all writing languages.

- 1 When you enter text using the on-screen keyboard, tap .
- 2 Tap , then tap **Keyboard settings**.
- 3 Tap **Writing languages**, then tap .
- 4 Select a keyboard layout variant.
- 5 Tap **OK** to confirm.

# Calling



## Making calls

You can make a call by manually dialling a phone number, by tapping a number saved in your contacts list, or by tapping the phone number in your call log view. You can also use the smart dial feature to quickly find numbers from your contacts list and call logs. To make a video call, you can use the Hangouts™ instant messaging and video chat application on your device. See *Instant messaging and video chat* on page 58.



- 1 Open your contacts list
- 2 View your call log entries
- 3 View all contact groups saved to your device
- 4 View more options
- 5 Delete number
- 6 Dialpad
- 7 Call button
- 8 Hide or show the dialer



### To make a call by dialling

- 1 From your Home screen, tap .
- 2 Find and tap **Phone**.
- 3 Enter the number of the recipient and tap .

### To make a call using smart dial

- 1 From your Home screen, tap .
- 2 Find and tap **Phone**.
- 3 Use the dialpad to enter letters or numbers that correspond to the contact you want to call. As you enter each letter or number, a list of possible matches appears.
- 4 Tap the contact you want to call.

### To make an international call

- 1 From your Home screen, tap .
- 2 Find and tap **Phone**.
- 3 Touch and hold 0 until a “+” sign appears.
- 4 Enter the country code, area code (without the initial zeros) and phone number, then tap .

## Showing or hiding your phone number

You can select to show or hide your phone number on call recipients' devices when you call them.

### To show or hide your phone number

- 1 From the Home screen, tap .
- 2 Find and tap **Settings** > **Call** > **Additional settings** > **Caller ID**.

## Receiving calls

### To answer a call



### To decline a call

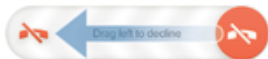

### To mute the ringtone for an incoming call

- When you receive the call, press the volume key.

## Using the answering machine

You can use the answering machine application in your device to answer calls when you are busy or miss a call. You can enable the automatic answering function and determine how many seconds to wait before the calls get answered automatically. You can also manually route calls to the answering machine when you are too busy to answer them. And you can access messages left on your answering machine directly from your device.

- ! Before using the answering machine, you must record a greeting message.

### To reject a call with the answering machine

- When an incoming call arrives, drag **Response options** upwards, then select **Reject with Answering Machine**.

### To record a greeting message for the answering machine

- 1 From your Home screen, tap .
- 2 Find and tap **Settings** > **Call** > **Answering Machine** > **Greetings**.
- 3 Tap **Record new greeting** and follow the on-screen instructions.

### To enable automatic answering

- 1 From your Home screen, tap .
- 2 Find and tap **Settings** > **Call** > **Answering Machine**.
- 3 Mark the **Answering Machine** checkbox.



- 💡 If you don't set a time delay for the automatic answering of calls, the default value is used.

### To set a time delay for automatic answering

- 1 From your Home screen, tap .
- 2 Find and tap **Settings** > **Call** > **Answering Machine**.
- 3 Tap **Pick up after**.
- 4 Adjust the time by scrolling up and down.
- 5 Tap **Done**.

### To listen to messages on the answering machine

- 1 From your Home screen, tap .
- 2 Find and tap **Settings > Call > Answering Machine > Messages**.
- 3 Select the voice message that you want to listen to.

 You can also listen to answering machine messages directly from the call log by tapping .

### Rejecting a call with a text message

You can reject a call with a text message. When you reject a call with such a message, the message is automatically sent to the caller and stored in the Messaging conversation with the contact.

You can select from a number of predefined messages available on your device, or you can create a new message. You can also create your own personalised messages by editing the predefined ones.

#### To reject a call with a text message

- 1 When an incoming call arrives, drag **Response options** upwards, then tap **Reject with message**.
- 2 Select a predefined message or tap  and write a new message.

#### To reject a second call with a text message

- 1 When you hear repeated beeps during a call, drag **Response options** upwards, then tap **Reject with message**.
- 2 Select a predefined message or tap  and write a new message.

#### To edit the text message used to reject a call

- 1 From your Home screen, tap .
- 2 Find and tap **Settings > Call > Reject call with message**.
- 3 Tap the message that you want to edit, then make the necessary changes.
- 4 Tap **OK**.

## Ongoing calls

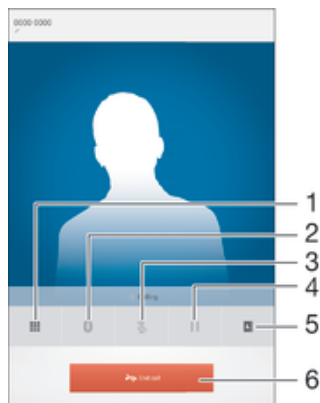

- 1 Enter numbers during a call
- 2 Toggle sound to a Bluetooth® headset
- 3 Mute the microphone during a call
- 4 Put the current call on hold or retrieve the call
- 5 Open your contacts list
- 6 End a call



#### To change the volume during a call

- Press the volume key up or down.

### To activate the screen during a call

- Briefly press .



## Using the call log

In the call log, you can view missed calls , received calls  and dialled calls .

### To view your missed calls

- 1 When you have missed a call,  appears in the status bar. Drag the status bar downwards.
- 2 Tap **Missed call**.

### To call a number from your call log

- 1 From your Home screen, tap .
- 2 Find and tap **Phone**. The call log view appears on the left part of the screen.
- 3 Tap the number that you want to call, then tap .

! You can also call a number by tapping Call back.

### To add a number from the call log to your contacts

- 1 From your Home screen, tap .
- 2 Find and tap **Phone**. The call log appears.
- 3 Tap the number, then tap **Add to Contacts**.
- 4 Tap the desired contact, or tap **Create new contact**.
- 5 Edit the contact details and tap **Done**.

### To hide the call log

- 1 From your Home screen, tap .
- 2 Find and tap **Phone**.
- 3 Tap  > **Hide call log**.

## Forwarding calls

You can forward calls, for example, to another phone number, or to an answering service.

### To forward calls

- 1 From your Home screen, tap .
- 2 Find and tap **Settings** > **Call**.
- 3 Tap **Call Forwarding** and select an option.
- 4 Enter the number to which you want to forward calls, then tap **Enable**.

### To turn off call forwarding

- 1 From your Home screen, tap .
- 2 Find and tap **Settings** > **Call** > **Call Forwarding**.
- 3 Select an option, then tap **Disable**.

## Restricting calls

You can block all or certain categories of incoming and outgoing calls. If you have received a PIN2 code from your service provider, you can also use a list of Fixed Dialling Numbers (FDNs) to restrict outgoing calls.

### To block incoming or outgoing calls

- 1 From your Home screen, tap .
- 2 Find and tap **Settings > Call**.
- 3 Tap **Call blocking**, and select an option.
- 4 Enter the password and tap **Enable**.

! When you set up call blocking for the first time, you need to enter a password to activate the call blocking function. You must use this same password later if you want to edit call blocking settings.

### To enable or disable fixed dialling

- 1 From your Home screen, tap .
- 2 Find and tap **Settings > Call > Fixed dialling numbers**.
- 3 Tap **Activate fixed dialling** or **Deactivate fixed dialling**.
- 4 Enter your PIN2 and tap **OK**.

### To access the list of accepted call recipients

- 1 From your Home screen, tap .
- 2 Find and tap **Settings > Call > Fixed dialling numbers > Fixed dialling numbers**.

### To change the SIM card PIN2

- 1 From the Home screen, tap .
- 2 Find and tap **Settings > Call**.
- 3 Tap **Fixed dialling numbers > Change PIN2**.
- 4 Enter the old SIM card PIN2 and tap **OK**.
- 5 Enter the new SIM card PIN2 and tap **OK**.
- 6 Confirm the new PIN2 and tap **OK**.

## Multiple calls

If you have activated call waiting, you can handle multiple calls at the same time. When it is activated, you will be notified by a beep if you receive another call.

### To activate or deactivate call waiting

- 1 From your Home screen, tap .
- 2 Find and tap **Settings > Call > Additional settings**.
- 3 To activate or deactivate call waiting, tap **Call waiting**.



### To answer a second call and put the ongoing call on hold

- When you hear repeated beeps during a call, drag  to the right.

### To reject a second call

- When you hear repeated beeps during a call, drag  to the left.

### To make a second call

- 1 During an ongoing call, tap .
- 2 Enter the number of the recipient or select a recipient from the contacts list, then tap . The first call is put on hold.

### To switch between multiple calls

- To switch to another call and put the current call on hold, tap **Switch to this call**.





## Conference calls

With a conference or multiparty call, you can have a joint conversation with two or more persons.

- ! For details about the number of participants that you can add to a conference call, contact your network operator.

### To make a conference call

- 1 During an ongoing call, tap .
- 2 Dial the number of the second participant and tap . The first participant is put on hold.
- 3 Tap  to add the second participant to the conference call.
- 4 Repeat steps 1 to 3 to add more call participants.

### To have a private conversation with a conference call participant

- 1 During an ongoing conference call, tap **Manage**.
- 2 Tap the telephone number of the participant to have a private conversation.
- 3 To end the private conversation and return to the conference call, tap .

### To release a participant from a conference call

- 1 During an ongoing conference call, tap the button showing the number of participants. For example, tap **3 participants** if there are three participants.
- 2 Tap  next to the participant you want to release.

### To end a conference call

- During the conference call, tap **End conference call**.

## Voicemail

If your subscription includes a voicemail service, callers can leave voice messages for you when you can't answer calls. Your voicemail service number is normally saved on your SIM card. If not, you can get the number from your service provider and enter it manually.

### To enter your voicemail number

- 1 From the Home screen, tap .
- 2 Find and tap **Settings** > **Call** > **Voicemail** > **Voicemail settings** > **Voicemail number**.
- 3 Enter your voicemail number.
- 4 Tap **OK**.



### To call your voicemail service

- 1 From your Home screen, tap .
- 2 Find and tap **Phone**.
- 3 Touch and hold **1**.

## Emergency calls

Your device supports international emergency numbers, for example, 112 or 911. You can normally use these numbers to make emergency calls in any country, with or without a SIM card inserted if you are within range of a network.

### To make an emergency call

- 1 From your Home screen, tap .
- 2 Find and Tap **Phone**.
- 3 Enter the emergency number and tap . To delete a number, tap .

- 💡 You can make emergency calls when no SIM card is inserted or when outgoing calls are barred.

To make an emergency call while the SIM card is locked

- 1 From the lock screen, tap **Emergency call**.
- 2 Enter the emergency number and tap .

# Contacts

## Transferring contacts

There are several ways to transfer contacts to your new device. Find out more about choosing a transfer method at [www.sonymobile.com/support](http://www.sonymobile.com/support).

### Transferring contacts using a computer

Xperia™ Transfer and Contacts Setup are applications within the PC Companion and the Sony™ Bridge for Mac computer programs that help you to collect contacts from your old device and transfer them to your new device. These applications support several device brands, including iPhone, Samsung, HTC, BlackBerry, LG, Motorola and Nokia.

You need:

- An Internet-connected computer.
- A USB cable for your old device.
- A USB cable for your new Android™ device.
- Your old device.
- Your new Android™ device.





#### To transfer contacts to your new device using a computer

- 1 Make sure that *PC Companion* is installed on the PC or that *Sony™ Bridge for Mac* is installed on the Apple® Mac® computer.
- 2 Open the PC Companion application or the Sony™ Bridge for Mac application, then click *Xperia™ Transfer* or *Contacts Setup* and follow the instructions to transfer your contacts.

### Transferring contacts using an online account

If you sync the contacts in your old device or your computer with an online account, for example, Google Sync™, Facebook™ or Microsoft® Exchange ActiveSync®, you can transfer your contacts to your new device using that account.



#### To synchronise contacts to your new device using a synchronisation account

- 1 From your Home screen, tap , then tap .
  - 2 Tap , then tap **Settings > Accounts & sync**.
  - 3 Select the account that you want to sync your contacts with, then tap  > **Sync now**.
- ! You need to be signed in to the relevant sync account before you can sync your contacts with it.

### Other methods for transferring contacts

There are several other ways to transfer contacts from your old device to your new device. For example, you can copy contacts to a memory card, use Bluetooth® technology, or save contacts to a SIM card. For more specific information about transferring the contacts from your old device, refer to the relevant User guide.



#### To import contacts from a memory card

- 1 From your Home screen, tap , then tap .
- 2 Press , then tap **Import contacts > SD card**.
- 3 Select the file that you want to import.

### To import contacts using Bluetooth® technology

- 1 Make sure you have the Bluetooth® function turned on and that your device is set to visible.
- 2 When you are notified of an incoming file to your device, drag the status bar downwards and tap the notification to accept the file transfer.
- 3 Tap **Accept** to start the file transfer.
- 4 Drag the status bar downwards. When the transfer is complete, tap the notification.
- 5 Tap the received file.

### To import contacts from a SIM card

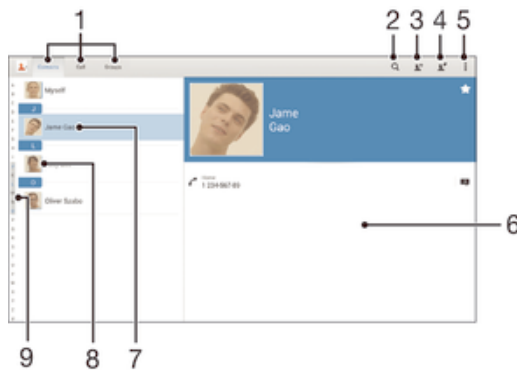

- ! You may lose information or get multiple contact entries if you transfer contacts using a SIM card.
- 1 From your Home screen, tap , then tap .
  - 2 Tap , then tap **Import contacts > SIM card**.
  - 3 To import an individual contact, find and tap the contact. To import all contacts, tap **Import all**.

## Searching and viewing contacts





- 1 View your contacts, call log and groups
- 2 Search for contacts
- 3 Add a contact
- 4 Edit a contact's details
- 5 View more options
- 6 Contact details
- 7 Tap to view a contact's details
- 8 Access communication options for the contact
- 9 Jump to contacts starting with the selected letter

### To search for a contact



- 1 From your Home screen, tap , then tap .
- 2 Tap  and enter a phone number, name or other information in the **Search contacts** field. The result list is filtered as you enter each character.

### To select which contacts to display in the Contacts application



- 1 From your Home screen, tap , then tap .
- 2 Press , then tap **Filter**.
- 3 In the list that appears, mark or unmark the desired options. If you have synchronised your contacts with a synchronisation account, that account appears in the list. To further expand the list of options, tap the account.

## Adding and editing contacts





### To add a contact

- 1 From your Home screen, tap , then tap .
  - 2 Tap .
  - 3 If you have synchronised your contacts with one or more accounts and you are adding a contact for the first time, you must select the account to which you want to add this contact. Alternatively, tap **Phone contact** if you only want to use and save this contact on your device.
  - 4 Enter or select the desired information for the contact.
  - 5 When you are finished, tap **Done**.
- ! After you select a synchronisation account in step 3, that account will show as the default account offered the next time you add a contact. When you save a contact to a particular account, that account will show as the default account to save to the next time you add a contact. If you have saved a contact to a particular account and want to change it, you need to create a new contact and select a different account to save it to.
- 💡 If you add a plus sign and the country code before a contact's phone number, you do not have to edit the number again when you make calls from other countries.





### To edit a contact

- 1 From your Home screen, tap , then tap .
  - 2 Tap the contact that you want to edit, then tap .
  - 3 Edit the desired information.
  - 4 When you are finished, tap **Done**.
- ! Some synchronisation services do not allow you to edit contact details.



### To associate a picture with a contact

- 1 From your Home screen, tap , then tap .
  - 2 Tap the contact you want to edit, then tap .
  - 3 Tap  and select the desired method for adding the contact picture.
  - 4 When you have added the picture, tap **Done**.
- 💡 You can also add a picture to a contact directly from the Album application.



### To personalise the ringtone for a contact

- 1 From your Home screen, tap , then tap .
- 2 Tap the contact that you want to edit, then tap .
- 3 Tap  > **Set ringtone**.
- 4 Select an option from the list or tap  to select a music file saved to your device, then tap **Done**.
- 5 Tap **Done**.



### To delete contacts

- 1 From your Home screen, tap , then tap .
- 2 Touch and hold the contact that you want to delete.
- 3 To delete all contacts, tap the downwards arrow to open the drop down menu, then select **Mark all**.
- 4 Tap , then tap **Delete**.

### To edit contact information about yourself

- 1 From your Home screen, tap , then tap .
- 2 Tap **Myself**, then tap .
- 3 Enter the new information or make the changes you want.
- 4 When you are done, tap **Done**.



### To create a new contact from a text message

- 1 From your Home screen, tap , then find and tap .
- 2 Tap  > **Save**.
- 3 Select an existing contact, or tap **Create new contact**.
- 4 Edit the contact information and tap **Done**.



## Favourites and groups

You can mark contacts as favourites so that you can get quick access to them from the Contacts application. You can also assign contacts to groups, to get quicker access to a group of contacts from within the Contacts application.

### To mark or unmark a contact as a favourite

- 1 From the Home screen, tap , then tap .
- 2 Tap the contact you want to add to or remove from your favourites.
- 3 Tap .

### To view your favourite contacts



- 1 From your Home screen, tap , then tap .
- 2 Tap **Call**. Your favourite contacts appear on the right part of the screen.

### To assign a contact to a group



- 1 In the Contacts application, tap the contact that you want to assign to a group.
- 2 Tap , then tap the bar directly under **Groups**.
- 3 Mark the checkboxes for the groups to which you want to add the contact.
- 4 Tap **Done**.

## Sending contact information





### To send your business card

- 1 From your Home screen, tap , then tap .
- 2 Touch and hold **Myself**.
- 3 Tap , then select a transfer method and follow the on-screen instructions.

### To send a contact

- 1 From your Home screen, tap , then tap .
- 2 Touch and hold the contact whose details you want to send.
- 3 Tap , then select a transfer method and follow the on-screen instructions.



### To send several contacts at once

- 1 From your Home screen, tap , then tap .
- 2 Press , then tap **Mark several**.
- 3 Mark the contacts you want to send, or select all if you want to send all contacts.
- 4 Tap , then select an available transfer method and follow the on-screen instructions.



## Avoiding duplicate entries in the Contacts application

If you synchronise your contacts with a new account or import contact information in other ways, you could end up with duplicate entries in the Contacts application. If this happens, you can join such duplicates to create a single entry. And if you join entries by mistake, you can separate them again later.

### To link contacts

- 1 From your Home screen, tap , then tap .
- 2 Tap the contact that you want to link with another contact.
- 3 Press , then tap **Link contact**.
- 4 Tap the contact whose information you want to join with the first contact, then tap **OK** to confirm. The information from the first contact is merged with the second contact, and the linked contacts are displayed as one contact in the Contacts list.



### To separate linked contacts

- 1 From your Home screen, tap , then tap .
- 2 Tap the linked contact that you want to edit, then tap .
- 3 Tap **Unlink contact** > **Unlink**.





## Backing up contacts

You can use a memory card or a SIM card to back up contacts.

### To export all contacts to a memory card

- 1 From your Home screen, tap , then tap .
- 2 Press , then tap **Export contacts** > **SD card**.
- 3 Tap **OK**.

### To export contacts to a SIM card

-  When you export contacts to a SIM card, not all information may get exported. This is due to memory limitations on SIM cards.
- 1 From your Home screen, tap , then tap .
  - 2 Press , then tap **Export contacts** > **SIM card**.
  - 3 Mark the contacts you want to export, or tap **Mark all** if you want to export all your contacts.
  - 4 Tap **Export**.
  - 5 Select **Add contacts** if you want to add the contacts to existing contacts on your SIM card, or select **Replace all contacts** if you want to replace the existing contacts on your SIM card.

# Messaging and chat



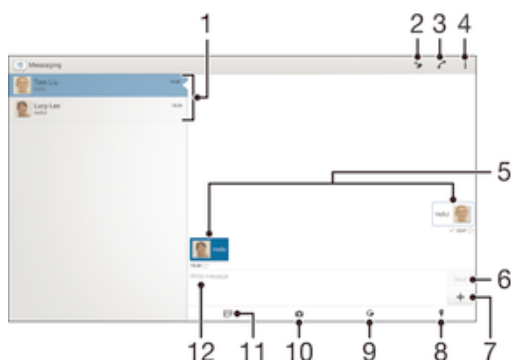

## Reading and sending messages

The Messaging application shows your messages as conversations, which means that all messages to and from a particular person are grouped together. To send multimedia messages, you need the correct MMS settings on your device. See *Internet and MMS settings* on page 24.





- 1 List of conversations
- 2 Create a new message
- 3 Call the message sender
- 4 View more options
- 5 Sent and received messages
- 6 Send a completed message
- 7 Add attachments
- 8 Attach a location
- 9 Attach a handwritten note or image
- 10 Take a photo and attach it
- 11 Attach a photo saved on your device
- 12 Text entry field

### To create and send a message



- 1 From your Home screen, tap , then find and tap .
  - 2 Tap .
  - 3 Enter the recipient's name or phone number, or other contact information that you have saved about the recipient, then select from the list that appears. If the recipient is not listed as a contact, enter the recipient's number manually.
  - 4 Tap **Write message** and enter your message text.
  - 5 If you want to add an attachment, tap  and select an option.
  - 6 To send the message, tap **Send**.
-  If you exit a message before sending, it gets saved as a draft. The conversation gets tagged with the word Draft.

### To read a received message



- 1 From your Home screen, tap , then find and tap .
- 2 Tap the desired conversation.
- 3 If the message is not yet downloaded, tap and hold the message, then tap **Download message**.





### To reply to a message

- 1 From your Home screen, tap , then find and tap .
- 2 Tap the conversation containing the message.
- 3 Enter your reply and tap **Send**.

### To forward a message



- 1 From your Home screen, tap , then find and tap .
- 2 Tap the conversation containing the message that you want to forward.
- 3 Touch and hold the message that you want to forward, then tap **Forward message**.
- 4 Enter the recipient's name or phone number, or other contact information that you have saved about the recipient, then select from the list that appears. If the recipient is not listed as a contact, enter the recipient's number manually.
- 5 Edit the message, if necessary, then tap **Send**.

### To save a file contained in a message you receive





- 1 From your Home screen, tap , then find and tap .
- 2 Tap the conversation you want to open.
- 3 If the message has not been downloaded yet, tap and hold the message, then tap **Download message**.
- 4 Touch and hold the file you want to save, then select the desired option.

## Organising your messages





### To delete a message

- 1 From your Home screen, tap , then find and tap .
- 2 Tap the conversation containing the message you want to delete.
- 3 Touch and hold the message you want to delete, then tap **Delete message** > **Delete**.



### To delete conversations

- 1 From your Home screen, tap , then find and tap .
- 2 Tap , then tap **Delete conversations**.
- 3 Mark the checkboxes for the conversations that you want to delete, then tap  > **Delete**.



### To star a message

- 1 From your Home screen, tap , then find and tap .
- 2 Tap the conversation you want to open.
- 3 In the message you want to star, tap .
- 4 To unstar a message, tap .

### To view starred messages





- 1 From your Home screen, tap , then find and tap .
- 2 Tap , then tap **Starred messages**.
- 3 All starred messages appear in a list.

### To search for messages



- 1 From your Home screen, tap , then find and tap .
- 2 Tap , then tap **Search**.
- 3 Enter your search keywords. The search results appear in a list.

## Calling from a message

### To call a message sender



- 1 From your Home screen, tap , then find and tap .
- 2 Tap a conversation.
- 3 Tap .
- 4 Tap .

### To save a sender's number as a contact



- 1 From your Home screen, tap , then find and tap .
- 2 Tap  > **Save**.
- 3 Select an existing contact, or tap **Create new contact**.
- 4 Edit the contact information and tap **Done**.

## Messaging settings

### To change your message notification settings

- 1 From your Home screen, tap , then find and tap .
- 2 Tap , then tap **Settings**.
- 3 To set a notification sound, tap **Notification tone** and select an option.
- 4 For other notification settings, check or uncheck the relevant checkboxes.

### To activate delivery reporting for outgoing messages

- 1 From your Home screen, tap , then find and tap .
  - 2 Tap , then tap **Settings** > **Notification settings**.
  - 3 Mark the **Delivery report** checkbox.
- ! After the delivery report function is turned on, a check mark is displayed in messages that have been successfully delivered.

## Instant messaging and video chat

You can use the Google Hangouts™ instant messaging and video chat application on your device to chat with friends who also use the application on computers, Android™ devices and other devices. You can turn any conversation into a video call with several friends, and you can send messages to friends even when they are offline. You can also view and share photos easily.

Before you start using Hangouts™, make sure that you have a working Internet connection and a Google™ account. Go to <http://support.google.com/hangouts> and click the "Hangouts on your Android" link to get more detailed information about how to use this application.

- ! The video call function only works on devices with a front camera.

### To use the Hangouts™ application



- 1 From your Home screen, tap .
- 2 Find and tap **Hangouts**.

# Email



## Setting up email

Use the email application in your device to send and receive email messages through your email accounts. You can have one or several email accounts at the same time, including corporate Microsoft Exchange ActiveSync accounts.

### To set up an email account

- 1 From your Home screen, tap .
  - 2 Find and tap **Email**.
  - 3 Follow the instructions that appear on the screen to complete the setup.
-  For some email services, you may need to contact your email service provider for information on detailed settings for the email account.

### To add an extra email account

- 1 From your Home screen, tap .
- 2 Find and tap **Email**.
- 3 Tap , then tap **Settings > Add account**.
- 4 Enter the email address and password, then tap **Next**. If the settings for the email account cannot be downloaded automatically, complete the setup manually.
- 5 When you are finished, tap **Next**.

## Sending and receiving email messages





- 1 View a list of all email accounts and recent folders
- 2 Write an email message
- 3 Search for email messages
- 4 Delete an email message
- 5 Mark a message as unread
- 6 Print an email message or save it as a PDF file
- 7 Access settings and options
- 8 List of email messages





### To download new email messages

- When the inbox is open, swipe downwards on the message list.

### To read your email messages

- 1 From your Home screen, tap .
- 2 Find and tap **Email**.
- 3 If you are using several email accounts, tap  and select the account that you want to check, then tap **Inbox** in the drop down menu. If you want to check all your email accounts at once, tap , then tap **Combined inbox** in the drop down menu.
- 4 In the email inbox, scroll up or down and tap the email message that you want to read.



### To create and send an email message

- 1 From your Home screen, tap , then find and tap **Email**.
- 2 If you are using several email accounts, tap  and select the account from which you want to send the email, then tap **Inbox** in the drop down menu.
- 3 Tap , then type the recipient's name or email address, or tap  and select one or more recipients from your Contacts list.
- 4 Enter the email subject and message text, then tap .

### To reply to an email message

- 1 In your email inbox, find and tap the message that you want to reply to, then tap **Reply** or **Reply all**.
- 2 Enter your reply, then tap .

### To forward an email message

- 1 In your email inbox, find and tap the message that you want to forward, then tap **Forward**.
- 2 Enter the recipient's email address manually, or tap  and select a recipient from your Contacts list.
- 3 Enter your message text, then tap .

### To view an email message attachment

- 1 Find and tap the email message containing the attachment that you want to view. Email messages with attachments are indicated by .
- 2 After the email message opens, tap **Load**. The attachment starts to download.
- 3 After the attachment finishes downloading, tap **View**.

### To save a sender's email address to your contacts



- 1 Find and tap a message in your email inbox.
- 2 Tap the name of the sender, then tap **OK**.
- 3 Select an existing contact, or tap **Create new contact**.
- 4 Edit the contact information, if desired, then tap **Done**.

## Email preview pane

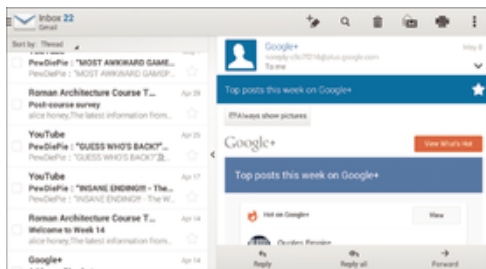
A preview pane is available for viewing and reading your email messages. Once activated, you can use it to view both the email message list and one selected email message at the same time.



### To change the email preview pane settings





- 1 From your Home screen, tap , then find and tap **Email**.
- 2 Tap , then tap **Settings** > **Split view**.
- 3 Select an option, or a combination of options, then tap **OK**.

### To read email messages using the preview pane





- 1 Make sure the preview pane is activated.
- 2 Open your email inbox.
- 3 Scroll up or down and tap the email message that you want to read.
- 4 To view the email message in fullscreen format, tap the split bar (located between the email list and the email body).
- 5 To return to the regular inbox view, tap the split bar again.

## Organising your email messages



### To sort your emails

- 1 From your Home screen, tap .
- 2 Find and tap **Email**.
- 3 If you are using several email accounts, tap  and select the account that you want to sort, then tap **Inbox** in the drop down menu. If you want to sort all your email accounts at once, tap , then tap **Combined inbox**.
- 4 Tap , then tap **Sort**.
- 5 Select a sorting option.

### To search for emails

- 1 From your Home screen, tap , then find and tap **Email**.
- 2 If you are using several email accounts, tap  and select the name of the account that you want to check, then tap **Inbox** in the drop down menu. If you want to search all your email accounts at once, tap , then tap **Combined view**.
- 3 Tap .
- 4 Enter your search text, then tap  on the keyboard.
- 5 The search result appears in a list sorted by date. Tap the email message that you want to open.

### To view all folders for one email account

- 1 From your Home screen, tap , then find and tap **Email**.
- 2 If you are using several email accounts, tap , and select the account you want to check.
- 3 Under the account that you want to check, select **Show all folders**.

### To delete an email message



- In your email inbox, flick the message that you want to delete to the right.

### To move an email message to another folder



- 1 In your email inbox, flick the message that you want to move to the left.
- 2 Tap **Move**, then select a folder.

## Email account settings



### To remove an email account from your device

- 1 From your Home screen, tap .
- 2 Find and tap **Email**.
- 3 Press , then tap **Settings**.
- 4 Select the account you want to remove.
- 5 Tap **Delete account** > **OK**.

### To change the inbox check frequency

- 1 From your Home screen, tap .
- 2 Find and tap **Email**.
- 3 Tap , then tap **Settings**.
- 4 Select the account for which you want to change the inbox check frequency.
- 5 Tap **Check frequency** > **Check frequency** and select an option.

### To set an Out of Office auto-reply in an Exchange Active Sync account

- 1 From your Home screen, tap , then find and tap **Email**.
- 2 Press , then tap **Settings**.
- 3 Select the EAS (Exchange Active Sync) account for which you want to set an Out of Office auto-reply.
- 4 Tap **Out of office**.
- 5 Drag the slider beside **Out of office** to the right to turn on the function.
- 6 If needed, mark the **Set time range** checkbox and set the time range for the auto reply.
- 7 Enter your Out of Office message in the body text field.
- 8 Tap **OK** to confirm.

## Gmail™

If you have a Google™ account, you can use the Gmail™ application to read and write email messages.



- 1 View a list of all Gmail accounts and recent folders
- 2 Write a new email message
- 3 Search for email messages
- 4 Access settings and options
- 5 List of email messages

### To learn more about Gmail™

- When the Gmail application is open, tap , then tap **Help**.

# Music

## Transferring music to your device

There are different ways to get music from a computer onto your device:

- Connect the device and computer using a USB cable and drag and drop music files directly into the file manager application on the computer. See *Managing files using a computer* on page 118.
  - If the computer is a PC, you can use the Media Go™ application from Sony and organise your music files, create playlists, subscribe to podcasts, and more. To learn more and download the Media Go™ application, go to <http://mediago.sony.com/enu/features>.
  - If the computer is an Apple® Mac®, you can use the Sony Bridge for Mac application to transfer your media files from iTunes to your device. To learn more and download Sony Bridge for Mac, go to [www.sonymobile.com/global-en/tools/bridge-for-mac/](http://www.sonymobile.com/global-en/tools/bridge-for-mac/).
- ! The Walkman® application may not support all music file formats. For more information about supported file formats and the use of multimedia (audio, image and video) files, download the White Paper for your device at [www.sonymobile.com/support](http://www.sonymobile.com/support).

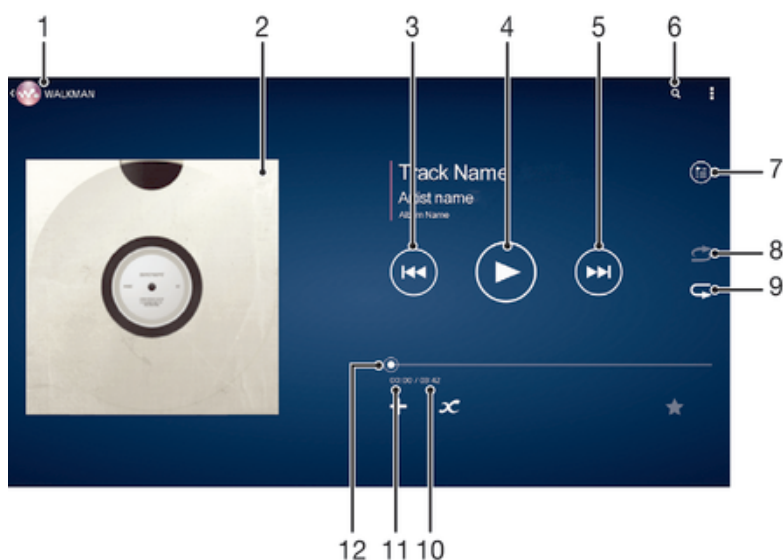

## Listening to music

Use the Walkman® application to listen to your favourite music and audio books.





- 1 Browse your music
- 2 Album art (if available)
- 3 Tap to go to the previous song in the play queue Touch and hold to rewind within the current song
- 4 Play or pause a song
- 5 Tap to go to the next song in the play queue Touch and hold to fast forward within the current song
- 6 Search songs on Music Unlimited and all songs saved to your device
- 7 View the current play queue
- 8 Shuffle songs in the current play queue
- 9 Repeat all songs in the current play queue
- 10 Total time length of current song
- 11 Elapsed time of current song
- 12 Progress indicator – Drag the indicator or tap along the line to fast forward or rewind

### To play a song using the Walkman® application

- 1 From your Home screen, tap , then find and tap .
- 2 Drag the left edge of the screen to the right.
- 3 Select a music category, for example, under **My Library**, tap **Artists**, **Albums** or **Songs**, then browse to the song that you want to open.
- 4 Tap a song to play it.

- ! You might not be able to play copyright-protected items. Please verify that you have necessary rights in material that you intend to share.

### To find song-related information online

- While a song is playing in the Walkman® application, tap the infinite button .
- 💡 The infinite button  gives you access to several sources of information including videos on YouTube™, lyrics, and artist info on Wikipedia.

### To adjust the audio volume

- Press the volume key.

### To minimise the Walkman® application

- When a song is playing, tap  to go to the Home screen. The Walkman® application stays playing in the background.

### To open the Walkman® application when it is playing in the background

- 1 While a song is playing in the background, tap the  to open the recently used applications window.
- 2 Tap the Walkman® application.

## Walkman® home screen menu

The Walkman® home screen menu gives you an overview of all the songs on your device as well as of the songs available on Music Unlimited. From here you can manage your albums and playlists, organise your music by mood and tempo using SensMe™ channels.

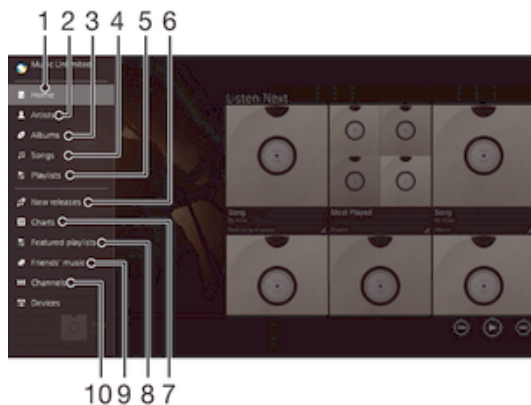



- 1 Return to the Walkman® home screen
- 2 Browse your music by artist
- 3 Browse your music by album
- 4 Browse your music by song
- 5 Browse all playlists
- 6 New releases (provided by Music Unlimited)
- 7 Charts (provided by Music Unlimited)
- 8 Featured playlists (provided by Music Unlimited)



- ! Sony Entertainment Network with Video Unlimited and Music Unlimited is not available in every market. Separate subscription required. Additional terms and conditions apply.

### To open the Walkman® home screen menu

- 1 From your Home screen, tap , then find and tap .
- 2 Drag the left edge of the screen to the right.

### To return to the Walkman® home screen

- When the Walkman® home screen menu is open, tap **Home**.
- When the Walkman® home screen menu is open, tap on the screen to the right of the menu.

### To update your music with the latest information

- 1 From the Walkman® home screen, tap .
- 2 Tap **Download music info** > **Start**. Your device searches online and downloads the latest available album art and song information for your music.

- 💡 The SensMe™ channels application is activated when you download music information.

### To enable the SensMe™ channels application

- From the Walkman® home screen, tap , then tap **Download music info** > **Start**.

- ! This application requires a Wi-Fi® network connection.

### To delete a song

- 1 From the Walkman® home screen, browse to the song that you want to delete.
- 2 Touch and hold the song title, then tap **Delete** from the list that appears.
- 3 Tap **Delete** again to confirm.

- 💡 You can also delete albums this way.

## Playlists

On the Walkman® home screen, you can create your own playlists from the music that is saved on your device.

### To create your own playlists

- 1 From the Walkman® home screen, touch and hold the name of the album or song that you want to add to a playlist.
- 2 In the menu that opens, tap **Add to** > **Create new playlist**.
- 3 Enter a name for the playlist and tap **OK**.

- 💡 You can also tap  to create a new playlist.

### To play your own playlists

- 1 Open the Walkman® home screen menu, then tap **Playlists**.
- 2 Under **Playlists**, select the playlist that you want to open.
- 3 If you want to play all songs, tap **Shuffle all**.

### To add songs to a playlist

- 1 From the Walkman® home screen, browse to the song or album that you want to add to a playlist.
- 2 Touch and hold the song or the album title, then tap **Add to**.
- 3 Tap the name of the playlist to which you want to add the album or song. The album or song is added to the playlist.

### To remove a song from a playlist

- 1 In a playlist, touch and hold the title of the song you want to delete.
- 2 Tap **Delete from playlist** from the list that appears.

### To delete a playlist

- 1 Open the Walkman® home screen menu, then tap **Playlists**.
- 2 Touch and hold the playlist that you want to delete.
- 3 Tap **Delete**.
- 4 Tap **Delete** again to confirm.

! You cannot delete smart playlists.

## Sharing music

### To share a song

- 1 From the Walkman® home screen, browse to the song or album that you want to share.
- 2 Touch and hold the song title, then tap **Share**.
- 3 Select an application from the list, then follow the on-screen instructions.

💡 You can also share albums and playlists in the same way.

### Sharing music on Facebook™

The Friends' music function collects links to music and music-related content that you and your friends have shared using Facebook™.

### To share and "Like" a song on Facebook™

- 1 While the song is playing in the Walkman® application, tap the album art.
- 2 Tap  to show that you "Like" the song on Facebook™. If desired, add a comment in the comments field.
- 3 Tap **Share** to send the song to Facebook™. If the song is received successfully, you will get a confirmation message from Facebook™.

### To manage music from your friends on Facebook™

- 1 Open the Walkman® home screen menu, then tap **Friends' music** > **Recent**.
- 2 Tap an item that you want to work on.
- 3 Manage the item as desired. For example, to "Like" the song, tap . To comment on the song, add a comment in the comments field.

### To view music that you shared on Facebook™

- 1 Open the Walkman® home screen menu, then tap **Friends' music** > **My shares**.
- 2 Scroll to an item that you want to open, then tap it. All comments that you posted on Facebook™ about the item, if any, are displayed.

## Enhancing the sound

### To improve the sound quality using the Equaliser

- 1 When a song is playing in the Walkman® application, tap .
- 2 Tap **Settings** > **Sound effects** > **Sound effects** > **Equalizer**.
- 3 To adjust the sound manually, drag the frequency band buttons up or down. To adjust the sound automatically, tap  and select a style.

### To turn on the Surround sound feature

- 1 When the Walkman® application is open, tap .
- 2 Tap **Settings** > **Sound effects** > **Sound effects** > **Surround sound (VPT)**.
- 3 Flick left or right to select a setting, then tap **OK** to confirm.

## Visualiser

The Visualiser adds visual effects to your songs as you play them. The effects for each song are based on the characteristics of the music. They change, for example, in response to changes in the music's loudness, rhythm and frequency level. You can also change the background theme.

### To turn on the Visualiser

- 1 In the Walkman® application, tap ☰.
  - 2 Tap **Visualizer**.
- 💡 Tap the screen to switch to full screen view.

### To change the background theme

- 1 In the Walkman® application, tap ☰.
- 2 Tap **Visualizer**.
- 3 Tap ☰ > **Theme** and select a theme.

## Recognising music with TrackID™

Use the TrackID™ music recognition service to identify a music track you hear playing in your surroundings. Just record a short sample of the song and you'll get artist, title and album info within seconds. You can purchase tracks identified by TrackID™ and you can view TrackID™ charts to see what TrackID™ users around the globe are searching for. For best results, use TrackID™ technology in a quiet area.



- 1 Record and identify music
- 2 View the search result history
- 3 View current music charts
- 4 Search music online
- 5 View TrackID™ options
- 6 View what music other people are tracking right now

- ! The TrackID™ application and the TrackID™ service are not supported in all countries/regions, or by all networks and/or service providers in all areas.

### To identify music using TrackID™ technology

- 1 From your Home screen, tap ☰.
  - 2 Find and tap **TrackID™**, then hold your device towards the music source.
  - 3 Tap 🎤. If the track is recognised by the TrackID™ service, the results appear on the screen.
- 💡 To return to the TrackID™ start screen, press ↶.

#### To view TrackID™ charts

- Open the **TrackID™** application, then tap **Charts**. A chart from your own region is shown.

#### To view TrackID™ charts from another region

- 1 Open the **TrackID™** application, then tap **Charts**.
- 2 Tap  > **Regions** and then select a country or region.

#### To buy a track recognised by the TrackID™ application

- 1 After a track has been recognised by the **TrackID™** application, tap **Download**.
  - 2 Follow the instructions in your device to complete your purchase.
- 💡 You can also select a track to buy by opening the History and Charts tabs. Or you can purchase tracks identified by an online text search in TrackID™.

#### To share a track

- 1 After a track has been recognised by the **TrackID™** application, tap **Share**, then select a sharing method.
- 2 Follow the instructions on your device to complete the procedure.

#### To view artist information for a track

- After a track has been recognised by the **TrackID™** application, tap **Artist info**.

#### To delete a track from the track history

- 1 Open the **TrackID™** application, then tap **History**.
- 2 Touch and hold the track title, then tap **Delete**.

## Music Unlimited online service

Music Unlimited is a subscription-based service that offers access to millions of songs over a mobile network or Wi-Fi® connection. You can manage and edit your personal music library in the cloud from a variety of devices, or sync your playlists and music using a PC that runs the Windows® operating system. Go to [www.sonyentertainmentnetwork.com](http://www.sonyentertainmentnetwork.com) for more information.

- ! Sony Entertainment Network with Video Unlimited and Music Unlimited is not available in every market. Separate subscription required. Additional terms and conditions apply.

#### To get started with Music Unlimited

- 1 Open the **Walkman** home screen.
- 2 Tap **Music Unlimited**, then follow the on-screen instructions to get started with the Music Unlimited service.

# FM radio

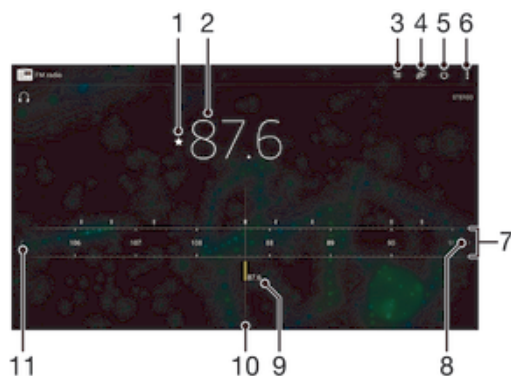

## Listening to the radio

The FM radio in your device works like any FM radio. For example, you can browse and listen to FM radio stations and save them as favourites. You must connect a wired headset or headphones to your device before you can use the radio. This is because the headset or headphones act as an antenna. After one of these devices is connected, you can then switch the radio sound to the speaker, if desired.



- 1 Save or remove a channel as a favourite
- 2 Tuned frequency
- 3 Favourites list
- 4 Launch the TrackID™ music recognition application
- 5 Radio on/off button
- 6 View menu options
- 7 Frequency band – drag left or right to move between channels
- 8 Move up the frequency band to search for a channel
- 9 A saved favourite channel
- 10 Tuning dial
- 11 Move down the frequency band to search for a channel

### To listen to the FM radio

- 1 Connect a headset or a set of headphones to your device.
- 2 From your Home screen, tap .
- 3 Find and tap **FM radio** . The available channels appear as you scroll through the frequency band.

- ! When you start the FM radio, available channels appear automatically. If a channel has RDS information, it appears a few seconds after you start listening to the channel.



### To move between radio channels

- Drag the frequency band left or right.



### To start a new search for radio channels

- 1 When the radio is open, press .
- 2 Tap **Search for channels**. The radio scans the whole frequency band, and all available channels are displayed.

### To switch the radio sound to the speaker

- 1 When the radio is open, press .
  - 2 Tap **Play in speaker**.
-  To switch the sound back to the wired headset or headphones, press  and tap Play in headphones.

### To identify a song on the FM radio using TrackID™

- 1 While the song is playing on your device's FM radio, tap .
  - 2 A progress indicator appears while the TrackID™ application samples the song. If successful, you are presented with a track result, or a list of possible tracks.
  - 3 Press  to return the FM Radio.
-  The TrackID™ application and the TrackID™ service are not supported in all countries/regions, or by all networks and/or service providers in all areas.

## Favourite radio channels

### To save a channel as a favourite

- 1 When the radio is open, navigate to the channel that you want to save as a favourite.
- 2 Tap .
- 3 Enter a name and select a colour for the channel, then press **Save**.

### To listen to a favourite radio channel



- 1 Tap .
- 2 Select an option.

### To remove a channel as a favourite

- 1 When the radio is open, navigate to the channel that you want to remove.
- 2 Tap , then tap **Delete**.

## Sound settings

### To switch between mono and stereo sound mode

- 1 When the radio is open, press .
- 2 Tap **Enable stereo sound**.
- 3 To listen to the radio in mono sound mode again, press  and tap **Force mono sound**.

### To select the radio region

- 1 When the radio is open, press .
- 2 Tap **Set radio region**.
- 3 Select an option.

### To adjust the Visualiser

- 1 When the radio is open, tap .
- 2 Tap **Visualizer**.
- 3 Select an option.

# Camera

## Taking photos and recording videos



- 1 Zoom in or out
- 2 Front camera
- 3 Main camera screen
- 4 Take photos or record video clips
- 5 Capturing mode settings icon
- 6 Go back a step or exit the camera
- 7 Switch between front and main camera
- 8 Display all settings

### To take a photo from the lock screen

- 1 To activate the screen, briefly press the power key (⏻).
- 2 To activate the camera, touch and hold and drag upwards.
- 3 After the camera opens, tap .

### To take a photo by touching the screen

- 1 Activate the camera.
- 2 Tap , then tap .
- 3 Drag the slider beside **Touch capture** to the right.
- 4 Point the camera towards the subject.
- 5 To activate auto focus, touch and hold a spot on the screen. When the focus frame turns blue, lift your finger to take the photo.

### To take a photo by tapping the on-screen camera button

- 1 Activate the camera.
- 2 Point the camera towards the subject.
- 3 Tap the on-screen camera button . The photo is taken as soon as you release your finger.



### To take a self-portrait using the front camera

- 1 Activate the camera.
- 2 Tap .
- 3 To take the photo, tap the on-screen camera button . The photo is taken as soon as you release your finger.

## To use the zoom function

- When the camera is open, press the volume key up or down.
- When the camera is open, pinch in or pinch out on the camera screen.

## To record a video by tapping the screen



- 1 Activate the camera.
- 2 Point the camera towards the subject.
- 3 Tap  to start recording.
- 4 Tap  to stop recording.

! This function is only available in Superior auto capturing mode.

## To view your photos and videos

- 1 Activate the camera, then tap a thumbnail to open a photo or video.
- 2 Flick left or right to view your photos and videos.





## To delete a photo or recorded video

- 1 Browse to the photo or video that you want to delete.
- 2 Tap the screen to make  appear.
- 3 Tap .
- 4 Tap **Delete** to confirm.

## Face detection

You can use face detection to bring an off-centre face into focus. The camera automatically detects up to five faces, indicated by white frames. A yellow frame shows which face has been selected for focus. Focus is set to the face closest to the camera. You can also tap one of the frames to select which face should be in focus.

## To turn on face detection

- 1 Activate the camera.
- 2 Tap , then select .
- 3 Tap , then tap .
- 4 Tap **Focus mode > Face detection**.



## To take a photo using face detection

- 1 When the camera is open and **Face detection** turned on, point the camera at your subject. Up to five faces can be detected, and each detected face is framed.
- 2 Tap the frame you want to select for focus. Do not tap if you want the camera to select focus automatically.
- 3 A yellow frame shows which face is in focus. Tap the screen to take the photo.

## Using Smile Shutter™ to capture smiling faces

Use Smile Shutter™ technology to photograph a face just as it smiles. The camera detects up to five faces and selects one face for smile detection and auto focus. When the selected face smiles, the camera automatically takes a photo.

## To turn on Smile Shutter™

- 1 Activate the camera.
- 2 Tap , then tap .
- 3 Tap **Smile Shutter** and select a smile level.





### To take a photo using Smile Shutter™



- 1 When the camera is open and Smile Shutter™ is turned on, point the camera at your subject. The camera selects which face to focus on.
- 2 The face selected appears inside a coloured frame and the photo is taken automatically.
- 3 If no smile is detected, tap the screen to take the photo manually.

## Adding the geographical position to your photos

Turn on geotagging to add the approximate geographical location (a geotag) to photos when you take them. The geographical location is determined either by wireless networks (mobile or Wi-Fi® networks) or GPS technology.













When  appears on the camera screen, geotagging is turned on but the geographical position has not been found. When  appears, geotagging is turned on and the geographical location is available, so your photo can get geotagged. When neither of these two symbols appears, geotagging is turned off.

### To turn on geotagging

- 1 From your Home screen, tap .
- 2 Tap **Settings** > **Location**.
- 3 Drag the slider beside **Location** to the right.
- 4 Activate the camera.
- 5 Tap , then tap .
- 6 Drag the slider beside **Geotagging** to the right.
- 7 Tap **OK**.

## General camera settings

### Capturing mode settings overview

-  **Superior auto**  
Optimise your settings to suit any scene.
-  **Manual**  
Adjust camera settings manually.
-  **Live on YouTube**  
Broadcast live video to YouTube™.
-  **Background defocus**  
Blur the background of your photos to make your subject look sharper in comparison.
-  **AR effect**  
Take photos or videos with virtual scenes and characters.
-  **Creative effect**  
Apply effects to photos or videos.
-  **Timeshift burst**  
Find the best photo from a burst of images.
-  **Social live**  
Broadcast live video to Facebook™.
-  **Sweep Panorama**  
Take wide-angle and panoramic photos.
-  **Face in**  
Take photos using the front and rear cameras at the same time.
-  **Multi camera**  
Record the same scene from multiple angles on a single screen.
-  **Sound Photo**  
Take photos with background sound.
-  **AR fun**  
Play in your camera view finder with virtual objects and enrich your photos or videos.

## Superior auto

Superior auto mode detects the conditions in which you are shooting and automatically adjusts the settings to ensure that you take the best photo possible.

## Manual mode

Use Manual mode when you want to manually adjust your camera settings for taking photos and videos.

## AR effect

You can apply AR (augmented reality) effects to your photos and make them more fun. This setting lets you integrate 3D scenes into your photos as you take them. Just select the scene you want and adjust its position in the viewfinder.



## Creative effect

You can apply different effects on your photos or videos. For example, you can add a Nostalgic effect to make photos look older or a Sketch effect for a more fun image.

## Sweep Panorama

You can take wide-angle and panoramic photos from the horizontal or vertical direction in an easy press-and-sweep motion.



### To take a panoramic photo

- 1 Activate the camera.
- 2 Tap , then select .
- 3 To select a shooting direction, tap .
- 4 Tap the screen and move the camera slowly and steadily to the direction of movement indicated on the screen.

## Timeshift burst

The camera takes a burst of 61 photos in a window of two seconds – one second before and after you press the camera key. So you can go back and find the perfect image.





### To use Timeshift burst

- 1 Activate the camera.
- 2 Tap , then select .
- 3 To take photos, press the camera key fully down and then release it. The photos taken appear in thumbnail view.
- 4 Scroll through the thumbnails and select the photo that you want to save, then tap .

## Social live

Social live is a camera shooting mode that lets you stream video live to your Facebook™ page. You just need to have an active internet connection and be logged into Facebook™. Videos can be up to 10 minutes long.

### To broadcast live video using Social live

- 1 Activate the camera.
- 2 Tap , then select .
- 3 Log in to your Facebook™ account.
- 4 Tap  to start broadcasting.
- 5 To take a photo during the broadcast, tap .
- 6 To stop broadcasting, tap .

## Background defocus mode

Use your camera's blurred background effect to make your subjects look sharper and more vivid in comparison to their background. In Background defocus mode, the camera takes two shots, identifies the background and then blurs it while keeping the subject sharp and in focus. It's just like shooting with a digital SLR camera. You can select from three different blur variations and tune the blur level in the preview display.

## Face in

You can use the Face in mode to turn on the front and main cameras at the same time, so you can take a photo of yourself together with the subject.

## Multi camera mode

Multi camera mode lets you take a photo from multiple angles by connecting your Xperia™ device with other Xperia™ devices and with Sony cameras that support Wi-Fi® or NFC. When your Xperia™ device is connected to one to three such devices, the image through the viewfinder of each device appears in your viewfinder at the same time.

## Downloading camera applications

You can download free or paid camera applications from Google Play™ or other sources. Before you start downloading, make sure that you have a working Internet connection, preferably over Wi-Fi® to limit data traffic charges.

### To download camera applications

- 1 Open the camera application.
- 2 Tap , then tap **Downloadable**.
- 3 Select the application that you want to download, and follow the instructions to complete the installation.

## Quick launch

Use Quick launch settings to launch the camera when the screen is locked.

### Launch only

After you drag  inwards, the main camera is launched from sleep mode.

### Launch and capture

After you drag  inwards, the still camera is launched from sleep mode and a photo is captured.

### Launch and record video

After you drag  inwards, the video camera is launched from sleep mode and starts recording.

### Off

## Geotagging

Tag photos with details of where you took them.

## Touch capture

Identify a focus area, and then touch the camera screen with your finger. The photo is taken as soon as you release your finger.

## Shutter sound

Choose to turn on or turn off the shutter sound.

## Data storage

You can choose to save your data either to a removable SD card or to your device's internal storage.

### Internal storage

Photos or videos are saved on the device memory.

### SD card

Photos or videos are saved on the SD card.

## Touch Block

Activate to disable the touch operation to avoid unintentional touches.

## White balance

This function adjusts the colour balance according to the lighting conditions. The white balance setting icon  is available on the camera screen.



### Auto

Adjusts the colour balance automatically to suit the lighting conditions.



### Incandescent

Adjusts the colour balance for warm lighting conditions, such as under light bulbs.



### Fluorescent

Adjusts the colour balance for fluorescent lighting.



### Daylight

Adjusts the colour balance for sunny outdoor conditions.



### Cloudy

Adjusts the colour balance for a cloudy sky.

! This setting is only available in Manual capturing mode.

## Still camera settings

### To adjust the still camera settings

- 1 Activate the camera.
- 2 To display all settings, tap .
- 3 Select the setting that you want to adjust, then edit as desired.

## Still camera settings overview

### Resolution

Choose between several resolutions and aspect ratios before taking a photo. A photo with a higher resolution requires more memory.

#### 8MP

##### 3264×2448(4:3)

8 megapixel resolution with 4:3 aspect ratio. Suitable for photos that you want to view on non-widescreen displays or print in high resolution.

#### 6MP

##### 3264×1836(16:9)

6 megapixel picture size with 16:9 aspect ratio. Suitable for photos that you want to view on non-widescreen displays or print in high resolution.

#### 3MP

##### 2048×1536(4:3)

3 megapixel resolution with 4:3 aspect ratio. Suitable for photos that you want to view on non-widescreen displays or print in high resolution.

#### 2MP

##### 1920×1080(16:9)

2 megapixel resolution with 16:9 aspect ratio. Suitable for photos you want to view on widescreen displays.

! This setting is only available in Manual capturing mode.

## Self-timer

With the self-timer you can take a photo without holding the device. Use this function to take self-portraits, or group photos where everyone can be in the photo. You can also use the self-timer to avoid shaking the camera when taking photos.

### **On (10 sec.)**

Set a 10-second delay from when you tap the camera screen until the photo is taken.

### **On (2 sec.)**

Set a 2-second delay from when you tap the camera screen until the photo is taken.

### **Off**

The photo is taken as soon as you tap the camera screen.

## Smile Shutter™

Use the Smile Shutter™ function to determine what kind of smile the camera reacts to before taking a photo.

## Focus mode

The focus function controls which part of a photo should be sharp. When continuous autofocus is on, the camera keeps adjusting focus so that the area within the yellow focus frame stays sharp.

### **Single autofocus**

The camera automatically focuses on the selected subject. Continuous autofocus is on. Touch and hold the camera screen until the yellow focus frame turns blue, indicating that the focus is set. The photo is taken when you release your finger.

### **Multi autofocus**

The focus is automatically set on several areas of the image. Touch and hold the camera screen until the yellow focus frame turns blue, indicating that the focus is set. The photo is taken when you release your finger. Continuous autofocus is off.

### **Face detection**

The camera automatically detects up to five human faces, indicated by frames on the screen. The camera automatically focuses on the nearest face. You can also select which face to focus on by tapping it on the screen. When you tap the camera screen, a blue frame shows which face is selected and in focus. Face detection cannot be used for all scene types. Continuous autofocus is on.

### **Touch focus**

Touch a specific area on the camera screen to set the area of focus. Continuous autofocus is off. Touch and hold the camera screen until the yellow focus frame turns blue, indicating that the focus is set. The photo is taken when you release your finger.

### **Object tracking**

When you select an object by touching it in the viewfinder, the camera tracks it for you.

! This setting is only available in Manual capturing mode.

## HDR

Use the HDR (High Dynamic Range) setting to take a photo against strong back light or in conditions where the contrast is sharp. HDR compensates for the loss of detail and produces a picture that is representative of both dark and bright areas.

! This setting is only available in Manual capturing mode.

## ISO

You can reduce image blurring caused by dark conditions or moving subjects by increasing the ISO sensitivity.

### **Auto**

Sets the ISO sensitivity automatically.

### **50**

Sets the ISO sensitivity to 50.

**100**  
Sets the ISO sensitivity to 100.

**200**  
Sets the ISO sensitivity to 200.

**400**  
Sets the ISO sensitivity to 400.

**800**  
Sets the ISO sensitivity to 800.

**1600**  
Sets the ISO sensitivity to 1600.

! This setting is only available in Manual capturing mode.

## Metering

This function automatically determines a well-balanced exposure by measuring the amount of light striking the image you want to capture.

**Center**  
Measures the centre of the image, and determines the exposure based on the brightness of the subject there.

**Spot**  
Adjusts the exposure in a very small part of the image that you want to capture.

**Face**  
Measures the amount of light on the face, and adjusts the exposure so that the face is neither too dark or too bright.

**Multi**  
Divides the image into multiple regions, and measures each region to determine a well-balanced exposure.

! This setting is only available in Manual capturing mode.

## Image stabiliser

When taking a photo, it can be difficult to hold the device steady. The stabiliser helps you by compensating for small movements of the hand.

! This setting is only available in Manual capturing mode.

## Preview

You can choose to preview photos or videos just after you shoot them.

**Unlimited**  
The preview of the photo or video appears after you shoot it.

**5 seconds**  
The preview of the photo or video appears for 5 seconds after you shoot it.

**3 seconds**  
The preview of the photo or video appears for 3 seconds after you shoot it.

**Edit**  
The photo or video opens for editing after you shoot it.



















**Off**  
The photo or video is saved after you shoot it, and no preview appears.

## Face registration

You can register faces with the Camera application so that the viewfinder automatically focuses on these faces when they appear in the viewfinder.

## Scene selection

Use the Scene selection feature to quickly set up the camera for common situations using pre-programmed scenes. The camera determines a number of settings for you to fit the selected scene, ensuring the best possible photo.

-  **Off**  
The Scene selection feature is off and you can take photos manually.
-  **Soft skin**  
Take photos of faces using an enhanced beauty effect.
-  **Soft snap**  
Use for shooting photos against a soft background.
-  **Anti motion blur**  
Use for minimising camera shake when shooting a slightly dark scene.
-  **Landscape**  
Use for landscape photos. The camera focuses on distant objects.
-  **Backlight correction HDR**  
Use to improve details in high contrast shots. The built-in backlight correction analyses the image and automatically adjusts it to give you a perfectly lit shot.
-  **Night portrait**  
Use for portrait photos taken at night or in poorly lit environments. Due to long exposure time, the camera must be held still or placed on a stable surface.
-  **Night scene**  
Use when taking photos at night or in poorly lit environments. Due to long exposure time, the camera must be held still or placed on a stable surface.
-  **Hand-held twilight**  
Use for taking hand-held low-light photos with reduced noise and blur.
-  **High sensitivity**  
Use for taking photos without a flash under low light conditions. Reduces blur.
-  **Gourmet**  
Use for shooting food arrangements in bright colour.
-  **Pet**  
Use for taking photos of your pet. Reduces blur and red eyes.
-  **Beach**  
Use for taking photos of seaside or lakeside scenes.
-  **Snow**  
Use in bright environments to avoid overexposed photos.
-  **Party**  
Use for indoor photos in poorly lit environments. This scene picks up indoor background lighting or candlelight. Due to long exposure time, the camera must be held still or placed on a stable surface.
-  **Sports**  
Use for photos of fast-moving objects. Short exposure time minimises motion blurring.
-  **Document**  
Use for photos of text or drawings. Gives the photo increased, sharper contrast.
-  **Fireworks**  
Use for taking photos of fireworks in all their splendour.

! This setting is only available in Manual capturing mode.

## Video camera settings

### To adjust the video camera settings

- 1 Activate the camera.
- 2 Tap one of the settings icons on the screen.
- 3 To display all settings, tap .
- 4 Select the setting that you want to adjust, then make your changes.

## Video camera settings overview

### Video resolution

Adjust the video resolution for different formats.

**Full HD****1920×1080(16:9)**

Full HD (Full High Definition) format with 16:9 aspect ratio. 1980×1080 pixels.

**HD****1280×720(16:9)**

HD (High Definition) format with 16:9 aspect ratio. 1280×720 pixels.

**VGA****640×480(4:3)**

VGA format with 4:3 aspect ratio.

**MMS**

Record videos suitable for sending in multimedia messages. The recording time of this video format is limited so that video files can fit in a multimedia message.

- ! This setting is only available in Manual capturing mode.

### Self-timer

With the self-timer you can record a video without holding the device. Use it to record group videos where everyone can be in the video. You can also use the self-timer to avoid shaking the camera when recording videos.

**On (10 sec.)**

Set a 10-second delay from when you tap the camera screen until the video begins to record.

**On (2 sec.)**

Set a 2-second delay from when you tap the camera screen until the video begins to record.

**Off**

The video begins to record as soon as you tap the camera screen.

### Smile Shutter™(video)

Use the Smile Shutter™ function to determine what kind of smile the camera reacts to before recording a video.

### Focus mode

The focus setting controls which part of a video should be sharp. When continuous autofocus is on, the camera keeps adjusting focus so that the area within the white focus frame stays sharp.

**Single autofocus**

The camera automatically focuses on the selected subject. Continuous autofocus is on.

**Face detection**

The camera automatically detects up to five human faces, indicated by frames on the screen. The camera automatically focuses on the nearest face. You can also select which face to focus on by tapping it on the screen. When you tap the camera screen, a yellow frame shows which face is selected and in focus. Face detection cannot be used for all scene types. Continuous autofocus is on.

**Object tracking**

When you select an object by touching it in the viewfinder, the camera tracks it for you.

- ! This setting is only available in Manual capturing mode.

### HDR video

Use the video HDR (High-Dynamic Range) setting to record a video against strong back light or in conditions where the contrast is sharp. Video HDR compensates for



the loss of detail and produces a picture that is representative of both dark and bright areas.

- ! This setting is only available in Manual capturing mode.

## Metering

This function automatically determines a well-balanced exposure by measuring the amount of light striking the image you want to capture.

### **Center**

Measures the centre of the image, and determines the exposure based on the brightness of the subject there.

### **Spot**

Adjusts the exposure in a very small part of the image that you want to capture.

### **Face**

Measures the amount of light on the face, and adjusts the exposure so that the face is neither too dark or too bright.

### **Multi**

Divides the image into multiple regions, and measures each region to determine a well-balanced exposure.

- ! This setting is only available in Manual capturing mode.

## SteadyShot™

When recording a video, it can be difficult to hold the device steady. The stabiliser helps by compensating for the small movements of your hand.

### **Standard**

Activate to remove the camera shakes.

### **Off**

The stabiliser is turned off.

## Microphone

Select whether to pick up the surrounding sound when recording videos.

## Preview

You can choose to preview videos just after you shoot them.

### **On**

The preview of the video appears after you shoot it.

### **Edit**

The video opens for editing after you shoot it.

### **Off**

The video is saved after you shoot it, and no preview appears.

## Scene selection

The Scene selection feature helps you to quickly set up the camera for common situations using pre-programmed video scenes. The camera determines a number of settings for you to fit the selected scene, ensuring the best possible video.

### **SCN Off**

The Scene selection feature is off and you can shoot videos manually.



### **Soft snap**

Use for shooting videos against soft backgrounds.



### **Landscape**

Use for videos of landscapes. The camera focuses on distant objects.

**Night**

When turned on, light sensitivity is increased. Use in poorly lit environments. Videos of fast-moving objects may get blurred. Hold your hand steady, or use a support. Turn off night mode when lighting conditions are good, to improve the video quality.

**Beach**

Use for videos of seaside or lakeside scenes.

**Snow**

Use in bright environments to avoid overexposed videos.

**Sports**

Use for videos of fast-moving objects. Short exposure time minimises motion blurring.

**Party**

Use for indoor videos in poorly lit environments. This scene picks up indoor background lighting or candlelight. Videos of fast-moving objects may get blurred. Hold your hand steady, or use a support.

! This setting is only available in Manual capturing mode.

# Photos and videos in Album

## Viewing photos and videos

Use the Album application to view photos and play videos that you've taken with your camera, or to view similar content that you've saved to your device. All photos and videos are displayed in a chronologically ordered grid.



- 1 Tap the icon to open the Album home screen menu
- 2 View menu options
- 3 A slideshow of all your images, or the ones you added to favourites
- 4 Drag the left edge of the screen to the right to open the Album home screen menu
- 5 The date of items in the group
- 6 Tap a photo or video to view it
- 7 Scroll up or down to view content

### To view photos and videos

- 1 From your Home screen, tap .
- 2 Find and tap **Album**.
- 3 Tap a photo or video to view it.
- 4 Flick left to view the next photo or video. Flick right to view the previous photo or video.

### To change the size of the thumbnails

- When viewing thumbnails of photos and videos in Album, spread two fingers apart to zoom in, or pinch two fingers together to zoom out.



### To zoom a photo

- When you are viewing a photo, spread two fingers apart to zoom in, or pinch two fingers together to zoom out.

### To watch a slideshow of your photos

- 1 When you are viewing a photo, tap the screen to display the toolbars, then tap  > **Slideshow** to start playing all the photos in an album.
- 2 Tap a photo to end the slideshow.

### To watch a slideshow of your photos with music

- 1 When you are viewing a photo, tap the screen to display the toolbars, then tap  > **SensMe™ slideshow**.
- 2 Select the music and theme that you want to use for the slideshow, then tap . The Album application analyses your photos and uses SensMe™ music data to play a slideshow.
- 3 To pause playing, tap the screen to display the controls, then tap .

### To play a video

- 1 In Album, find and tap the video that you want to play.
- 2 Tap **Movies** > **Just once**.
- 3 If the playback controls are not displayed, tap the screen to display them. To hide the controls, tap the screen again.

### To pause a video

- 1 When a video is playing, tap the screen to display the controls.
- 2 Tap .

### To fast forward and rewind a video

- 1 When a video is playing, tap the screen to display the controls.
- 2 Drag the progress bar marker left to rewind, or right to fast forward.

### To adjust the volume of a video

- Press the volume key.

## Sharing and managing photos and videos

You can share photos and videos that you've stored on your device. You can also manage them in different ways. For example, you can work with photos in batches, delete photos and link them to contacts.

- ! You might not be able to copy, send or transfer copyright-protected items. Also, some items may not send if the file size is too large.

### To share a photo or video

- 1 In Album, find and tap the photo or video that you want to share.
- 2 Tap the screen to display the toolbars, then tap .
- 3 Tap the application that you want to use to share the photo, then follow the steps to send it.

### To use a photo as a contact picture

- 1 When you are viewing a photo, tap the screen to display the toolbars, then tap  > **Use as** > **Contact picture**.
- 2 If asked, select **Contacts** > **Just once**, then select a contact.

### To use a photo as wallpaper

- 1 When you are viewing a photo, tap the screen to display the toolbars, then tap  > **Use as** > **Wallpaper**.
- 2 Follow the instructions on the screen.



### To rotate a photo

- 1 When you are viewing a photo, tap the screen to display the toolbars, then tap .
- 2 Select **Rotate**. The photo is saved in the new orientation.

### To delete a photo or video

- 1 When you are viewing a photo, tap the screen to display the toolbars, then tap .
- 2 Tap **Delete**.

### To work with batches of photos or videos in Album

- 1 When viewing thumbnails of photos and videos in Album, tap , then tap **Select items**.
  - 2 Tap the items that you want to work with. Selected items are indicated by a blue frame.
  - 3 Use the tools in the toolbars to work with your selected items.
-  To activate selection mode, you can also touch and hold an item until its frame turns blue. Then you can tap other items to select them.

### Analysing photos with faces in Album

You can analyse any photos on your device that feature people's faces. Once activated, the photo analysis feature stays on, and new photos get analysed as they are added. After running an analysis, you can then group all photos of the same person in one folder.

#### To turn on the photo analysis feature

- 1 From your Home screen, tap .
- 2 Find and tap **Album**.
- 3 Drag the left edge of the Album home screen to the right, then tap **Faces**. All photos on your device get analysed and grouped in the Unnamed faces folder.

#### To name a face

- 1 In the **Faces** tile, tap the **Unnamed faces** folder, then browse to the **Other faces** folder and choose the face that you want to name.
- 2 Tap **Add name**.
- 3 Type a name, then tap **Done > Add as new person**.

#### To edit a face name

- 1 When you are viewing a face in full screen view, tap the screen to display the toolbars, then tap  > **Edit name tags**.
- 2 Tap **OK**.
- 3 Tap the name of the face that you want to edit.
- 4 Edit the name, then tap **Done > Add as new person**.



### Editing photos with the Photo editor application

You can edit and apply effects to original photos that you've taken with your camera. For example, you can change the light effects. After you save the edited photo, the original unchanged version of the photo remains on your device.



#### To edit a photo

- When you are viewing a photo, tap the screen to display the toolbars, then tap .



### To crop a photo

- 1 When you are viewing a photo, tap the screen to display the toolbars, then tap .
- 2 If prompted, select **Photo editor > Just once**.
- 3 Tap  > **Crop**.
- 4 Tap  to select an option.
- 5 To adjust the crop frame, touch and hold the edge of the crop frame. When the squares at the edges disappear, drag inward or outward to resize the frame.
- 6 To resize all sides of the crop frame at the same time, touch and hold one of the four corners to make the squares at the edges disappear, then drag the corner accordingly.
- 7 To move the crop frame to another area of the photo, touch and hold inside the frame, then drag it to the desired position.
- 8 Tap **Apply Crop**.
- 9 To save a copy of the photo as you cropped it, tap **Save**.



### To apply special effects to a photo

- 1 When you are viewing a photo, tap the screen to display the toolbars, then tap .
- 2 If prompted, select **Photo editor > Just once**.
- 3 Tap , then select an option.
- 4 Edit the photo as desired, then tap **Save**.



### To improve a photo using advanced settings

- 1 When you are viewing a photo, tap the screen to display the toolbars, then tap .
- 2 If prompted, select **Photo editor > Just once**.
- 3 Tap , then select an option.
- 4 To save a copy of the edited photo, tap **Save**.

### To adjust the light settings for a photo

- 1 When you are viewing a photo, tap the screen to display the toolbars, then tap .
- 2 If prompted, select **Photo editor > Just once**.
- 3 Tap , then select an option.
- 4 To save a copy of the edited photo, tap **Save**.

### To set the saturation level of colours in a photo

- 1 When you are viewing a photo, tap the screen to display the toolbars, then tap .
- 2 If prompted, select **Photo editor > Just once**.
- 3 Tap , then select an option.
- 4 To save a copy of the edited photo, tap **Save**.

## Album home screen menu

Through the Album home screen menu you can browse to all your photo albums, including albums of photos and videos taken with the camera as well as content that you share online via services such as PlayMemories Online, Picasa™ and Facebook. Once you are logged in to such services, you can manage content, comment on photos and videos, and view comments from friends. From the Album application, you can also add geotags to photos, perform basic editing tasks, and use methods such as Bluetooth® wireless technology and email to share content.



- 1 View photos and videos using the PlayMemories Online service
- 2 Return to the Album application home screen
- 3 View all photos and videos taken with your device's camera
- 4 View all photos and videos saved to your device in different folders
- 5 View your favorite photos and videos
- 6 View all photos with faces
- 7 View your photos on a map or in globe mode
- 8 View photos and videos on the same network
- 9 View photos and videos on Facebook™
- 10 View photos and videos on Picasa™
- 11 View photos using the Flickr™ online service

! The PlayMemories Online service is not available in all countries or regions.

#### To view photos from online services in Album

- 1 From your Home screen, tap .
- 2 Find and tap **Album**, then drag the left edge of the Album home screen to the right.
- 3 Tap the desired online service, then follow the on-screen instructions to get started with it. All available online albums that you have uploaded to the service are displayed.
- 4 Tap any album to view its content, then tap a photo in the album.
- 5 Flick left to view the next photo or video. Flick right to view the previous photo or video.

#### To view and add comments to online album content

- 1 When viewing a photo from an online album, tap the screen to display the toolbars, then tap  to view the comments.
- 2 Enter your comments in the input field, then tap **Post**.

#### To "Like" a photo or video on Facebook™

- While viewing a photo or video from one of your Facebook™ albums, tap the screen to display the toolbars, then tap  to show that you "Like" the item on Facebook™.

## Viewing your photos on a map

Adding location information to photos is referred to as geotagging. You can view and tag your photos on a map and show friends and family where you were when you took a particular photo. See *Adding the geographical position to your photos* on page 73 for more information.

- ! If you have turned on location detection and activated geotagging in the camera, you can tag your photos directly for map viewing at a later stage.



- 1 View geotagged photos in Globe view
- 2 Search a location on the map
- 3 View menu options
- 4 Double tap to zoom in. Pinch to zoom out. Drag to view different parts of the map
- 5 A group of photos and/or videos geotagged with the same location
- 6 Thumbnails of the selected group of photos and/or videos. Tap an item to view it in full screen

💡 If several photos were taken at the same location, only one of them appears on the map. The total number of photos appears in the top right corner, for example, . To view all photos in the group, tap the cover photo and then tap one of the thumbnails at the bottom of the screen.

#### To add a geotag to a photo

- 1 When you are viewing a photo, tap the screen to display the toolbars, then tap **Tap to set location** to open the map screen.
- 2 Find and tap the desired location to put the photo on the map.
- 3 To adjust the location of the photo, tap the location on the map to where you want to move the photo.
- 4 When you are finished, tap **OK** to save the geotag and return to the photo viewer.

#### To view geotagged photos on a map

- 1 From your Home screen, tap .
- 2 Find and tap **Album**.
- 3 Drag the left edge of the Album home screen to the right, then tap **Places**.
- 4 Tap the photo that you want to view on a map.

#### To view geotagged photos on a globe

- 1 From your Home screen, tap .
- 2 Find and tap **Album**.
- 3 Drag the left edge of the Album home screen to the right, then tap **Places** > .
- 4 Tap the photo that you want to view on a globe.

#### To change the geotag of a photo

- 1 When viewing a photo on the map in Album, touch and hold the photo until its frame turns blue, then tap the desired location on the map.
- 2 Tap **OK**.

#### To change the map view

- When viewing the map in Album, tap , then select **Classic view** or **Satellite view**.



# Videos

## Watching videos in the Movies application

Use the Movies application to play movies and other video content that you've saved or downloaded to your device. The Movies application also helps you get poster art, plot summaries, genre info and director details for each movie. You can also play your movies on other devices that are connected to the same network.



- ! Some video files may not be playable in the Movies application.



- 1 View menu options
- 2 Display the most recently played video
- 3 Drag the left edge of the screen to the right to browse all downloaded and saved videos
- 4 Tap to play saved or downloaded video files
- 5 Scroll up or down to view content

- ! Sony Entertainment Network with Video Unlimited is not available in every market. Additional terms and conditions apply.

### To play a video in Movies

- 1 From your Home screen, tap , then find and tap **Movies**.
- 2 Find and tap the video that you want to play. If the video is not displayed on the screen, drag the left edge of the screen to the right to open the Movies home screen menu, then find and tap the video that you want to play.
- 3 To display or hide the controls, tap the screen.
- 4 To pause playing, tap . To resume playing, tap .
- 5 To rewind, drag the progress bar marker to the left. To fast forward, drag the progress bar marker to the right.

### To play a video on an external device

- 1 When the video is playing, tap the screen to display all the controls.
- 2 Tap  > **Throw**.
- 3 Select an external device on which to play the video. If there is no external device available, follow the on-screen instructions to add one.

### To change settings in Movies

- 1 From your Home screen, tap , then find and tap **Movies**.
- 2 Tap  > **Settings**, then change the settings as desired.

### To change the sound settings while a video is playing

- 1 While a video is playing, tap the screen to display the controls.
- 2 Tap , then tap **Audio settings**.
- 3 Mark the checkboxes for the sound settings that you want to activate.
- 4 When you're finished, tap **OK**.

### To share a video

- 1 When a video is playing, tap , then tap **Share**.
- 2 In the menu that opens, tap the application that you want to use to share the selected video, then follow the relevant steps to send it.

## Transferring video content to your device

Before you start using the Movies application, it's a good idea to transfer movies, TV shows and other video content to your device from other devices, such as a computer. There are several ways to transfer your content:

- Connect your device to a computer using a USB cable and drag and drop the video files directly using the file manager application on the computer. See *Managing files using a computer* on page 118.
- If you have a PC, use the Media Go™ application from Sony to organise content and transfer video files to your device via the PC. To learn more and download the Media Go™ application, go to <http://mediago.sony.com/enu/features>.
- If your computer is an Apple® Mac®, you can use Sony Bridge for Mac to transfer video files from iTunes to your device. To learn more and download Sony Bridge for Mac, go to [www.sonymobile.com/global-en/tools/bridge-for-mac/](http://www.sonymobile.com/global-en/tools/bridge-for-mac/).

## Managing video content

### To get movie information manually

- 1 Make sure that your device has an active data connection.
  - 2 From your Home screen, tap , then find and tap **Movies**.
  - 3 Drag the left edge of the screen to the right to open the Movies home screen menu, then browse through the different categories and to the video file that you want to get information.
  - 4 Touch and hold the thumbnail for the video, then tap **Search for info**.
  - 5 In the search field, enter keywords for the video, then tap the confirm key on the keyboard. All matches are displayed in a list.
  - 6 Select a search result, then tap **Done**. The download of the information begins.
- ! You can get information about newly added videos automatically every time the Movies application opens if you mark the Get video details checkbox under Settings.
- 💡 If the downloaded information is not correct, search again using different keywords.

### To clear information about a video

- 1 From your Home screen, tap , then find and tap **Movies**.
- 2 Drag the left edge of the screen to the right to open the Movies home screen menu, then browse through the different categories and to the video file that you want to edit.
- 3 Touch and hold the video thumbnail, then tap **Clear info**.

### To delete a video

- 1 From your Home screen, tap , then find and tap **Movies**.
- 2 Drag the left edge of the screen to the right to open the Movies home screen menu, then browse through the different categories and to the video file that you want to delete.
- 3 Touch and hold the video thumbnail, then tap **Delete** from the list that appears.
- 4 Tap **Delete** again to confirm.

## Video Unlimited service



Use the Video Unlimited service to buy and rent movies or TV shows that you can view not only on your Android™ device, but also on a PC, PlayStation® Portable (PSP®), PlayStation® 3, PlayStation® 4 or PlayStation® Vita. Select your pick from the

latest Hollywood releases, action movies, comedies, classics, and a range of other categories.

You need to create a Sony Entertainment Network account if you want to buy or rent movies through the Video Unlimited service. If you already have a PlayStation® network account, then you can use that account instead.

- ! Sony Entertainment Network with Video Unlimited and Music Unlimited is not available in every market. Separate subscription required. Additional terms and conditions apply.

#### To get started with Video Unlimited

- 1 From your Home screen, tap .
- 2 Find and tap .
- 3 If you are starting Video Unlimited for the first time, tap **Next**, then tap **Start Now** to go to the main screen of Video Unlimited. Alternatively, tap **Sign In**, then follow the on-screen instructions to sign in to your account, or create a new account.

# Connectivity

## Mirroring the screen of your device on a TV using a cable

You can connect your device to a TV set using an MHL cable or an HDMI cable and view content saved in your device on the TV screen. When you connect your device using either an MHL or an HDMI cable to a compatible TV set, the TV launcher application opens. This application plays media files stored on your device and displays them on TVs and other devices.

- 💡 MHL and HDMI cables and adaptors are sold separately.

### To view content from your device on a TV which supports MHL input

- 1 Connect your device to the TV using an MHL cable.  appears in your device's status bar after a connection is established.
- 2 The **TV launcher** application starts automatically. Follow the instructions to view your media files on the TV.

### To view content from your device on a TV which supports HDMI™ input

- 1 Connect your device to an MHL adaptor, and connect the adaptor to a USB power supply.
- 2 Connect the adaptor to a TV using an HDMI™ cable.  appears in your device's status bar after a connection is established.
- 3 The **TV launcher** application starts automatically. Follow the instructions to view your media files on the TV.

### To view help about using the TV remote control

- 1 While your device is connected to the TV set, drag the status bar downwards to open the Notification panel.
- 2 Tap **MHL connected**.

- 💡 You can also press the yellow button on the TV remote control to open the Notification panel.



### To disconnect your device from the TV set

- Disconnect the MHL™ cable or the MHL adaptor from your device.

## Mirroring the screen of another Xperia™ device wirelessly on your device

You can use the Screen mirroring feature to share the screen of another Xperia™ device on the screen of your device without using a cable connection. Wi-Fi Direct™ technology creates a wireless connection between the two devices. The other Xperia™ device, for example, an Xperia™ phone or tablet, must support Wi-Fi CERTIFIED Miracast™.

### To mirror the screen of the Xperia™ device on your device

- 1 Your device: From your Home screen, tap .
- 2 Find and tap **Settings > Xperia™ Connectivity > Screen mirroring > OK**.
- 3 Tap **Standby mode**.
- 4 Other device: From your Home screen, tap .
- 5 Find and tap **Settings > Xperia™ Connectivity > Screen mirroring > Turn on Screen mirroring**.
- 6 Tap **OK** and select a device.
- 7 Your device: Tap **Accept** to connect with your device.

## Mirroring the screen of your device wirelessly on a TV

You can use Screen mirroring feature to show the screen of your device on a TV or other large display without using a cable connection. Wi-Fi Direct™ technology creates a wireless connection between the two devices, so you can sit back and enjoy your favourite photos from the comfort of your couch. You can also use this feature to listen to music from your device via the TV's speakers.

- ! Your TV must support screen mirroring based on Wi-Fi CERTIFIED Miracast™ for the functionality described above to work. If your TV does not support screen mirroring, you may need to purchase a wireless display adapter separately.
- ! When using screen mirroring, the image quality may sometimes be negatively impacted if there is interference from other Wi-Fi® networks.

### To mirror the screen of your device on a TV screen

- 1 TV: Follow the instructions in the User guide for your TV to turn on the screen mirroring function.
  - 2 Your device: From your Home screen, tap .
  - 3 Find and tap **Settings > Xperia™ Connectivity > Screen mirroring**.
  - 4 Tap **Turn on Screen mirroring** and select the device to which you want to mirror content.
- ! When using screen mirroring, do not cover the Wi-Fi antenna area of your device.
  - ! Your TV must support screen mirroring based on Wi-Fi CERTIFIED Miracast™ for the functionality described above to work.

## Sharing content with DLNA Certified™ devices

You can view or play media content saved to your device on other devices such as, for example, a TV, or a computer. Such devices must be DLNA Certified™ by the Digital Living Network Alliance and all devices must be connected to the same Wi-Fi® network in order for content to be shared. You can also view or play content from other DLNA Certified™ devices on your device.

After you set up the sharing of content between devices, you can, for example, listen to music files stored on your home computer from your device, or view photos taken with your device's camera on a large-screen TV.

### Playing files from DLNA Certified™ devices on your device

When you play files from another DLNA Certified™ device on your device, this other device acts as a server. In other words, it shares content over a network. The server device must have its content sharing function enabled and give access permission to your device. It also must be connected to the same Wi-Fi® network as your device.

#### To play a shared track on your device

- 1 Make sure the devices that you want to share files with are connected to the same Wi-Fi® network as your device.
- 2 From your Home screen, tap , then find and tap **WALKMAN**.
- 3 Select a device from the list of connected devices.
- 4 Browse the folders of the connected device and select the track that you want to play. The track starts playing automatically.

#### To play a shared video on your device

- 1 Make sure the devices that you want to share files with are connected to the same Wi-Fi® network as your device.
- 2 From your Home screen, tap , then find and tap **Movies**.
- 3 Select a device from the list of connected devices.
- 4 Browse the folders of the connected device and select the video that you want to play.





### To view a shared photo on your device

- 1 Make sure the devices that you want to share files with are connected to the same Wi-Fi® network as your device.
- 2 From your Home screen, tap .
- 3 Find and tap **Album** > **My albums**. All your available online albums and connected devices are displayed.
- 4 Select a device from the list of connected devices.
- 5 Browse the folders of the connected device and select a photo to view it.



### Playing files from your device on DLNA Certified™ devices

Before you can view or play media files from your device on other DLNA Certified™ devices, you must set up file sharing on your device. The devices that you share content with are called client devices. For example, a TV, computer or tablet can act as client devices. Your device works as a media server when it makes content available to client devices. When you set up file sharing on your device, you must also give access permission to client devices. After you do so, such devices appear as registered devices. Devices that are waiting for access permission are listed as pending devices.



### To set up file sharing with other DLNA Certified™ devices

- 1 Connect your device to a Wi-Fi® network.
  - 2 From your Home screen, tap , then find and tap .
  - 3 Tap , then tap **Media server**.
  - 4 To turn on the **Share media** function, drag the slider.  appears in the status bar. Your device can now work as a media server.
  - 5 Connect your computer or other devices to the same Wi-Fi® network as your device.
  - 6 A notification appears in the status bar of your device. Open the notification and set access permissions for each device.
- ! The instructions for setting up file sharing using DLNA™ differ depending on the client device. Refer to your client device User guide for more information. If the device cannot connect to a client on the network, check if your Wi-Fi® network is working.
- 💡 You can also access the Media server menu under Settings > Xperia™ Connectivity > Media server settings. If you close the Media server view, the file sharing function stays running in the background.



### To stop sharing files with other DLNA Certified™ devices

- 1 From your Home screen, tap , then find and tap .
- 2 Tap , then tap **Media server**.
- 3 Drag the slider to turn off the **Share media** function.



### To set access permissions for a pending device

- 1 From your Home screen, tap , then find and tap .
- 2 Tap , then tap **Media server**.
- 3 Select a device from the **Pending devices** list.
- 4 Select an access permission level.





### To change the name of a registered device

- 1 From your Home screen, tap , then find and tap .
- 2 Tap , then tap **Media server**.
- 3 Select a device from the **Registered devices** list, then select **Change name**.
- 4 Enter a new name for the device.

### To change the access level of a registered device

- 1 From your Home screen, tap , then find and tap .
- 2 Tap , then tap **Media server**.
- 3 Select a device from the **Registered devices** list.
- 4 Tap **Change access level** and select an option.

### To get help about sharing content with other DLNA Certified™ devices





- 1 From your Home screen, tap , then find and tap .
- 2 Tap , then tap **Media server**.
- 3 Tap .

## Playing files on a Digital Media Renderer device



Using DLNA™ technology, you can push media content saved on your device to another device connected to the same Wi-Fi® network. The other device must be able to function as a Digital Media Renderer (DMR) device and render or play content received from your device. A TV with DLNA features or a PC running Windows® 7 or higher are examples of DMR devices.

- ! The settings for enabling the Digital Media Renderer may vary depending on the device. Refer to the user guide of the DMR device for more information.
- ! Content secured with Digital Rights Management (DRM) cannot be played on a Digital Media Renderer device using DLNA™ technology.

### To view photos or videos from your device on a DMR device

- 1 Make sure that you have correctly set up the DMR device and that it is connected to the same Wi-Fi® network as your device.
  - 2 From your Home screen, tap .
  - 3 Find and tap **Album**.
  - 4 Browse to and open the file that you want to view.
  - 5 Tap the screen to display the toolbars, then tap  and select a DMR device to share your content with. The selected files start playing in chronological order on the device that you select.
  - 6 To disconnect from the DMR device, tap  and select your device. The file stops playing on the DMR device but continues playing on your device.
- 💡 You can also share a video from the Movies application on your device by tapping the video and then tapping .

### To play a music track from your device on a DMR device

- 1 Make sure that you have correctly set up the DMR device and that it is connected to the same Wi-Fi® network as your device.
- 2 From your Home screen, tap , then find and tap **WALKMAN**.
- 3 Select a music category and browse to the track that you want to share, then tap the track.
- 4 Tap  and select a DMR device to share your content with. The track plays automatically on the device that you select.
- 5 To disconnect from the DMR device, tap  and select your device. The track stops playing on the DMR device but continues playing on your device.

## Connecting your device to USB mass storage devices

You can use a USB Host adapter to connect your device to USB mass storage devices.

- ! USB Host adapters are sold separately. Sony does not guarantee that all USB mass storage devices are supported by your device.

### To access content on a USB mass storage device using a USB Host adapter

- 1 Attach the USB Host adapter to your device, then connect the adapter to the USB mass storage device.
  - 2 To access files and folders on the USB storage device, use a file manager app such as File Commander.
- 💡 You can also open the relevant media application on your device to view content directly. For example, open the Album application to view photos stored on the USB mass storage device, or open the Walkman application to play music files.

### To disconnect a USB mass storage device

- 1 From your Home screen, tap .
  - 2 Find and tap **Settings > Storage > Unmount USB storage**.
  - 3 Tap **OK**.
  - 4 Detach the USB Host adapter from your device.
- 💡 You can also disconnect the USB device via the Notification panel.

## Playing games on a TV using a DUALSHOCK™3/ DUALSHOCK™4 wireless controller

You can play games stored on your phone on a TV and control the games using a DUALSHOCK™3/DUALSHOCK™4 wireless controller.

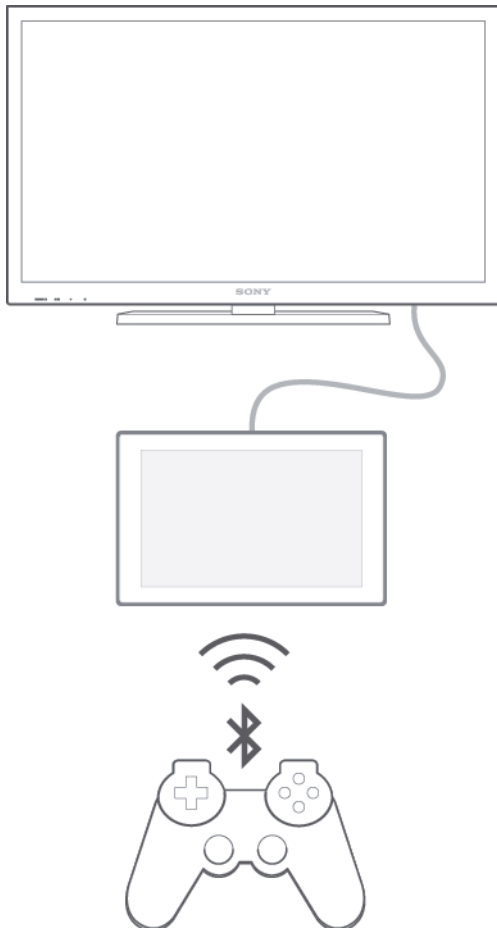

- 💡 To set up a connection between a DUALSHOCK™ wireless controller and your device, a USB Host adapter is required.



### To set up a connection with a DUALSHOCK™3 wireless controller

- 1 Make sure the Bluetooth® function on your device is turned on.
- 2 Connect a USB Host adapter to your device.
- 3 Connect the DUALSHOCK™3 wireless controller to the USB Host adapter.
- 4 When **Controller connected(wired)** appears in the status bar at the top of your device screen, unplug the USB Host adapter.
- 5 When **Controller connected(wireless)** appears in the status bar, a wireless connection is established.

### To set up a connection with a DUALSHOCK™4 wireless controller

- 1 From your Home screen, tap .
- 2 Find and tap **Settings > Xperia™ Connectivity > DUALSHOCK™3/ DUALSHOCK™4**.
- 3 Select **DUALSHOCK™4**, and follow the on-screen instructions to complete the connection.

## NFC

Use Near Field Communications (NFC) to share data with other devices, such as a video, photo, web page address, music file or contact. You can also use NFC to scan tags that give you more information about a product or service as well as tags that activate certain functions on your device.



NFC is a wireless technology with a maximum range of one centimetre, so the devices sharing data must be held close to each other. Before you can use NFC, you must first turn on the NFC function, and the screen of your device must be active.

- ! NFC may not be available in all countries and/or regions.

### To turn on the NFC function



- 1 From your Home screen, tap .
- 2 Find and tap **Settings > More....**
- 3 Mark the **NFC** checkbox.

### To share a contact with another device using NFC

- 1 Make sure that both devices have the NFC function turned on, and that both screens are active.
- 2 To view contacts, go to your Home screen, tap , then tap .
- 3 Tap the contact that you want to share.
- 4 Hold your device and the receiving device back to back so that the NFC detection areas of each device touch each other. When the devices connect, a thumbnail of the contact appears.
- 5 Tap the thumbnail to start the transfer.
- 6 When the transfer is done, the contact information is displayed on the screen of the receiving device and is also saved on the receiving device.

- 💡 The front part of your device that corresponds to the NFC detection area (at the back) is also NFC enabled. So you can also touch this part of your device to other devices during NFC transactions.



### To share a music file with another device using NFC

- 1 Make sure that both your device and the receiving device have the NFC function turned on, and that both screens are active.
  - 2 To open the "WALKMAN™" application, tap , then find and tap .
  - 3 Select a music category and browse to the track you want to share.
  - 4 Tap the track to play it. You can then tap  to pause the track. The transfer works whether the track is playing or paused.
  - 5 Hold your device and the receiving device back to back so that the NFC detection areas of each device touch each other. When the devices connect, a thumbnail of the track appears.
  - 6 Tap the thumbnail to start the transfer.
  - 7 When the transfer is done, the music file plays immediately on the receiving device. At the same time, the file is saved on the receiving device.
- ! The front part of your device that corresponds to the NFC detection area (at the back) is also NFC enabled. So you can also touch this part of your device to other devices during NFC transactions.

### To share a photo or video with another device using NFC

- 1 Make sure that both devices have the NFC function turned on, and that both screens are active.
  - 2 To view photos and videos in your device, go to your Home screen, tap , then find and tap **Album**.
  - 3 Tap the photo or video that you want to share.
  - 4 Hold your device and the receiving device back to back so that the NFC detection areas of each device touch each other. When the devices connect, a thumbnail of the track appears.
  - 5 Tap the thumbnail to start the transfer.
  - 6 When the transfer is done, the photo or video is displayed on the screen of the receiving device. At the same time, the item is saved on the receiving device.
- 💡 The front part of your device that corresponds to the NFC detection area (at the back) is also NFC enabled. So you can also touch this part of your device to other devices during NFC transactions.

### To share a web address with another device using NFC

- 1 Make sure that both devices have the NFC function turned on, and that both screens are active.
  - 2 From your Home screen, tap .
  - 3 To open the web browser, find and tap .
  - 4 Load the web page that you want to share.
  - 5 Hold your device and the receiving device back to back so that the NFC detection areas of each device touch each other. When the devices connect, a thumbnail of the track appears.
  - 6 Tap the thumbnail to start the transfer.
  - 7 When the transfer is done, the web page is displayed on the screen of the receiving device.
- 💡 The front part of your device that corresponds to the NFC detection area (at the back) is also NFC enabled. So you can also touch this part of your device to other devices during NFC transactions.

## Scanning NFC tags

Your device can scan various kinds of NFC tags. For example, it can scan embedded tags on a poster, on a billboard advertisement, or beside a product in a retail store. You can receive additional information, such as a web address.

### To scan an NFC tag

- 1 Make sure that your device has the NFC function turned on and that the screen is active.
- 2 Place your device over the tag so that the NFC detection area touches it. Your device scans the tag and displays the content collected. Tap the content of the tag to open it.
- 3 To open the tag, tap it.

### Connecting to an NFC compatible device

You can connect your device to other NFC compatible devices produced by Sony, such as a speaker or a headphone. When establishing this kind of connection, refer to the User guide of the compatible device for more information.

- ! You may need to have Wi-Fi® or Bluetooth® activated on both devices for the connection to work.

## Bluetooth® wireless technology



Use the Bluetooth® function to send files to other Bluetooth® compatible devices, or to connect to handsfree accessories. Turn on the Bluetooth® function in your device and create wireless connections to other Bluetooth® compatible devices such as computers, handsfree accessories, and phones. Bluetooth® connections work better within 10 metres (33 feet), with no solid objects in between. In some cases you have to manually pair your device with other Bluetooth® devices.

- ! Interoperability and compatibility among Bluetooth® devices can vary.

### To turn on the Bluetooth® function and make your device visible

- 1 From your Home screen, tap .
- 2 Find and tap **Settings**.
- 3 Tap the on-off switch beside **Bluetooth** so that the Bluetooth® function is turned on.
- 4 Tap **Bluetooth**. Your device and a list of available Bluetooth® devices appear.
- 5 Tap your device name to make your device visible to other Bluetooth® devices.

### To adjust your device's visibility time to other Bluetooth® devices

- 1 From your Home screen, tap .
- 2 Find and tap **Settings > Bluetooth**.
- 3 Press  and select **Visibility timeout**.
- 4 Select an option.

### Naming your device

You can give your device a name. This name is shown to other devices after you have turned on the Bluetooth® function and your device is set to visible.

### To give your device a name

- 1 Make sure that the Bluetooth® function is turned on.
- 2 From your Home screen, tap .
- 3 Find and tap **Settings > Bluetooth**.
- 4 Tap  and select **Rename tablet**.
- 5 Enter a name for your device.
- 6 Tap **Rename**.

## Pairing with another Bluetooth® device

When you pair your device with another device, you can, for example, connect your device to a Bluetooth® headset or a Bluetooth® car kit and use these other devices to share music.

Once you pair your device with another Bluetooth® device, your device remembers this pairing. When pairing your device with a Bluetooth® device, you may need to enter a passcode. Your device will automatically try the generic passcode 0000. If this does not work, refer to the user guide for your Bluetooth® device to get the device passcode. You do not need to re-enter the passcode the next time you connect to a previously paired Bluetooth® device.

- ! Some Bluetooth® devices, for example, most Bluetooth® headsets, require you to both pair and connect with the other device.
- ! You can pair your device with several Bluetooth® devices, but you can only connect to one Bluetooth® profile at the same time.



### To pair your device with another Bluetooth® device

- 1 Make sure that the device you want to pair with has the Bluetooth® function activated and is visible to other Bluetooth® devices.
- 2 From your device's Home screen, tap .
- 3 Find and tap **Settings** > **Bluetooth**. All available Bluetooth® devices appear in a list.
- 4 Tap the Bluetooth® device that you want to pair with.
- 5 Enter a passcode, if required, or confirm the same passcode on both devices. Your device and the other device are now paired.

### To connect your device to another Bluetooth® device

- 1 From your Home screen, tap .
- 2 Find and tap **Settings** > **Bluetooth**.
- 3 Tap the Bluetooth® device to which you want to connect.

### To unpair a Bluetooth® device

- 1 From your Home screen, tap .
- 2 Find and tap **Settings** > **Bluetooth**.
- 3 Under **Paired devices**, tap  beside the name of the device that you want to unpair.
- 4 Tap **Unpair**.

## Sending and receiving items using Bluetooth® technology

Share items with other Bluetooth® compatible devices such as phones or computers. You can send and receive several kinds of items using the Bluetooth® function, such as:

- Photos and videos
- Music and other audio files
- Contacts
- Web pages



### To send items using Bluetooth®

- 1 Receiving device: Make sure the Bluetooth® function is turned on and that the device is visible to other Bluetooth® devices.
- 2 Sending device: Open the application which contains the item that you want to send, and scroll to the item.
- 3 Depending on the application and on the item that you want to send, you may need to, for example, touch and hold the item, open the item, and press . Other ways to send an item may exist.
- 4 Select **Bluetooth**.
- 5 Turn on Bluetooth® if you are asked to do so.
- 6 Tap the name of the receiving device.
- 7 Receiving device: If asked, accept the connection.
- 8 Sending device: If asked, confirm the transfer to the receiving device.
- 9 Receiving device: Accept the incoming item.

### To receive items using Bluetooth®

- 1 Make sure that the Bluetooth® function is on and is visible to other Bluetooth® devices.
- 2 The sending device now starts sending data to your device.
- 3 If prompted, enter the same passcode on both devices, or confirm the suggested passcode.
- 4 When you are notified of an incoming file to your device, drag the status bar downwards and tap the notification to accept the file transfer.
- 5 Tap **Accept** to start the file transfer.
- 6 To view the progress of the transfer, drag the status bar downwards.
- 7 To open a received item, drag the status bar downwards and tap the relevant notification.

### To view files you have received using Bluetooth®

- 1 From your Home screen, tap .
- 2 Find and tap **Settings > Bluetooth**.
- 3 Press  and select **Show received files**.

## One-touch setup

You can use the One-touch setup function to automatically launch the setup of several features that work wirelessly between two Xperia™ devices. For example, you can use One-touch setup to launch the configuration of basic settings for Screen mirroring and Xperia Link™. Once you've completed the setup, then you only need one touch every time to launch these features.

The One-touch setup function is activated using NFC. Other one-touch features include Bluetooth® and Media Server. For more information about the setup of Screen mirroring, Media Server, NFC and Bluetooth®, refer to the relevant sections of the User guide.

### To start One-touch setup on your device

- 1 From your Home screen, tap .
- 2 Find and tap **Settings > Xperia™ Connectivity > One-touch setup**. The NFC function is automatically turned on.
- 3 Make sure the NFC function on the other Xperia™ device is turned on.
- 4 Make sure the screens of both devices are unlocked and active.
- 5 Hold the two devices together so that the NFC detection area of each device touches the other. The one-touch setup function launches automatically.

! Both devices must support the One-touch setup function.

 The front part of your device that corresponds to the NFC detection area (located at the back of your device) is also NFC enabled. So you can also touch this part of your device to other devices during NFC transactions.

# Smart apps and features that save you time

## Controlling accessories and settings with Smart Connect

Use the Smart Connect application to set what happens in your device when you connect or disconnect an accessory. For example, you can decide to always start the FM radio application when you connect a headset.

You can also use Smart Connect to set a specific action or a group of actions to launch on your device at certain times of the day. For example, when you connect your headset between 7am and 9am, you can decide that:

- The Walkman® application starts.
- The web browser opens the morning paper.
- The ring volume is set to vibrate.

With Smart Connect, you can also manage your accessories such as SmartTags and SmartWatch. Refer to the User guide of the specific accessory for more information.



1 Tap to display all added devices

2 Tap to display all added events



3 Add a device or an event

4 View menu options

5 Tap to activate an event

6 Tap to view details of an event

### To create a Smart Connect event

- 1 From your Home screen, tap , then find and tap .
  - 2 If you are opening Smart Connect for the first time, tap **OK** to close the introduction screen.
  - 3 On the **Events** tab, tap **+**.
  - 4 If you are creating an event for the first time, tap **OK** again to close the introduction screen.
  - 5 Add conditions under which you want to trigger the event. A condition could be the connection with an accessory, or a specific time interval, or both.
  - 6 Tap **→** to continue.
  - 7 Add what you want to happen when you connect an accessory, and set other settings as desired.
  - 8 Tap **→** to continue.
  - 9 Set an event name, then tap **Finish**.
-  To add a Bluetooth® accessory, you have to first pair it with your device.

### To edit a Smart Connect event

- 1 Start the Smart Connect application.
- 2 On the **Events** tab, tap an event.
- 3 If the event is switched off, drag the slider to the right to turn it on.
- 4 Tap **Edit**, then adjust the settings as desired.

### To delete an event

- 1 Start the Smart Connect application.
- 2 On the **Events** tab, touch and hold the event that you want to delete, then tap **Delete event**.
- 3 Tap **Delete** to confirm.

💡 You can also open the event that you want to delete, then tap  > Delete event > Delete.

## Managing devices

Use the Smart Connect application to manage a range of smart accessories that you can connect to your device, including SmartTags, SmartWatch and Smart Wireless Headset pro from Sony. Smart Connect downloads any necessary applications and also finds third-party applications, when available. Previously connected devices show in a list that allows you to get more information about the features of each device.

### To pair and connect an accessory

- 1 Start the Smart Connect application. If you are opening Smart Connect for the first time, tap **OK** to close the introduction screen.
- 2 Tap **Devices**, then tap **+**.
- 3 Tap **OK** to start searching for devices.
- 4 In the search result list, tap the name of the device that you want to add.

### To adjust the settings for a connected accessory

- 1 Pair and connect the accessory with your device.
- 2 Start the Smart Connect application.
- 3 Tap **Devices**, then tap the name of the connected accessory.
- 4 Adjust the desired settings.

## Using your device as a fitness hub with ANT+™

You can use your device with health and fitness products that also support ANT+™ technology. For example, if you go running with an ANT+™ compatible heart rate monitor and a foot pod (to measure pace and distance), you can collect all the data from the run on your device. You can then analyse your performance and see how you can improve.

You can download a range of applications from Google Play™ that support ANT+™ sport, fitness and health devices. For information about ANT+™ compatible products, go to [www.thisisant.com/directory](http://www.thisisant.com/directory).

## Using your device as a wallet

Use your device as a wallet to pay for goods without reaching for your real wallet. All of your installed payment services are put together to be viewed and managed. Note that when making a payment, you must first turn on the NFC function before your device touches a card reader. For more information about NFC, see *NFC* on page 97.

! Mobile payment services may not yet be available in all regions.

### To manage payment services

- 1 From your Home screen, tap .
- 2 Find and tap **Settings** > **Tap & pay**. A list of payment services appears.
- 3 Manage the payment services as desired, for example, change your default payment service.



# Travel and maps

## Using location services

Location services allow applications such as Maps and the camera to use information from mobile and Wi-Fi® networks as well as Global Positioning System (GPS) information to determine your approximate location. If you're not within a clear line of sight to GPS satellites, your device can determine your location using the Wi-Fi® function. And if you're not within range of a Wi-Fi® network, your device can determine your location using your mobile network.

In order to use your device to find out where you are, you need to enable location services.

### To enable location services

- 1 From your Home screen, tap .
- 2 Find and tap **Settings** > **Location**.
- 3 Drag the slider beside **Location** to the right.
- 4 Tap **Agree** to confirm.

- ! When you enable location services, both GPS satellites and Google's location service get enabled by default. You can disable either option manually.

### To allow Google apps to access your location

- 1 Make sure you are signed in to your Google™ account from your device.
- 2 From your Home screen, tap .
- 3 Find and tap **Settings** > **Google** > **Location**.
- 4 Drag the slider beside **Location** to the right.
- 5 Tap **Agree** to confirm.

## Improving GPS accuracy

The first time you use the GPS function in your device, it can take 5 to 10 minutes for your location to be found. To help the search, make sure you have a clear view of the sky. Stand still and don't cover the GPS antenna (the highlighted area in the image). GPS signals can pass through clouds and plastic, but not through most solid objects such as buildings and mountains. If your location isn't found after a few minutes, move to another location.



## Google Maps™ and navigation

Use Google Maps™ to track your current location, view real-time traffic situations and receive detailed directions to your destination.

When you view a map, you use data traffic to get an Internet connection, and data is transferred to your device. So it's a good idea to save a map and make it available offline before you take a trip. This way, you can avoid high roaming costs.

- ! The Google Maps™ application requires the use of an Internet connection when used online. You may incur data connection charges when you connect to the Internet from your device.

Contact your network operator for more information. The Google Maps™ application may not be available in every market, country or region.





- 1 View help and options.
- 2 Enter an address or name to search for a location, for example, a restaurant's name or address.
- 3 Select a transportation mode and get directions to your destination.
- 4 View your account profile.
- 5 Location mark – shows a searched location on the map.
- 6 Show your current location.

#### To show your location on the map

- 1 From your Home screen, tap .
- 2 Find and tap **Maps**, then tap .

#### To search for a location

- 1 From your Home screen, tap .
- 2 Find and tap **Maps**.
- 3 In the search field, enter the name of the location you want to find.
- 4 Tap the Enter key on the keyboard to start the search, or select a suggested location from the list. If the search is successful, the location is indicated by  on the map.

#### To get directions

- 1 While viewing a map, tap .
- 2 Select a transportation mode, then enter your starting point and your destination. The recommended routes appear in a list.
- 3 Tap an option from the list of recommended routes to view the directions on a map.

#### To make a map available offline

- 1 While viewing a map, tap the search field.
- 2 Scroll to the bottom and tap Make this map area available offline. The area shown on the map gets saved to your device.

#### To learn more about Google Maps™

- When you use Google Maps™, tap , then tap **Help**.

## Using data traffic when travelling

When you travel outside of your home mobile network, you might need to access the Internet using mobile data traffic. In this case, you need to activate data roaming on your device. It is recommended to check the relevant data transmission charges in advance.

### To activate or deactivate data roaming

- 1 From your Home screen, tap .
  - 2 Find and tap **Settings** > **More...** > **Mobile networks**.
  - 3 Mark or unmark the **Data roaming** checkbox.
- ! You can't activate data roaming when mobile data is turned off.

## Using your device with a car infotainment system

Connect your device to a MirrorLink™ certified car infotainment system using a USB cable to, for example, use a navigation app or play music from your device while driving. The car infotainment system mirrors all features on your device and gives you access to all applications. When connected, you can navigate the apps using the car infotainment system controls.

- ! Some applications may not be available in driving mode. Also, protected data, such as videos that are strictly protected under Digital Rights Management (DRM), is not made available via MirrorLink™.



### To connect your device to a car infotainment system

- Connect your device and the car infotainment system using a USB cable. The screen of your device appears on the screen of the infotainment system.
- ! You may need to start MirrorLink™ manually if the connection between your device and the infotainment system is not established automatically.

### To start MirrorLink™ manually



- 1 Make sure that your device is connected to the car infotainment system using a USB cable.
- 2 From your Home screen, tap .
- 3 Find and tap **Settings** > **Xperia™ Connectivity** > **MirrorLink™**.
- 4 Tap **Start MirrorLink™**, then tap **OK**.
- 5 If the connection still fails, tap **Network address** to change to another network address in case the same network address is being used by other services such as Bluetooth® and Wi-Fi®, and then try again.

## Airplane mode

In Airplane mode, the network and radio transceivers are turned off to prevent disturbance to sensitive equipment. However, you can still play games, listen to music, watch videos and other content, as long as all this content is saved on your memory card or internal storage. You can also be notified by alarms, if alarms are activated.

- 💡 Turning on Airplane mode reduces battery consumption.

### To turn on Airplane mode

- 1 From your Home screen, tap .
  - 2 Find and tap **Settings > More....**
  - 3 Mark the **Airplane mode** checkbox.
-  You can also press and hold down the power key  and then select Airplane mode in the menu that opens.

# Calendar and alarm clock

## Calendar

Use the Calendar application to manage your time schedule. If you have signed into and synchronised your device with one or several online accounts that include calendars, for example, your Google™ account or Xperia™ with Facebook account, then calendar events from these accounts will also appear in the Calendar application. You can select which calendars you want to integrate into the combined Calendar view.

When an appointment time approaches, your device plays a notification sound to remind you. Also,  appears in the status bar.

- 💡 You can also synchronise your Outlook calendar with your device using PC Companion. If you do so, all appointments from your Outlook calendar will appear in the calendar view of your device.



- 1 Select a view type and the calendars that you want to view
- 2 Add a calendar event
- 3 Search for events
- 4 Return to the current date
- 5 Access settings and other options
- 6 Agenda for the selected day
- 7 Flick left or right to browse more quickly



### To create a calendar event

- 1 From your Home screen, tap , then tap **Calendar**.
- 2 Tap **+New event**.
- 3 If you have synchronised your calendar with one or more accounts, select the account to which you want to add this event. If you only want to add this event on your device, tap **Device calendar**.
- 4 Enter or select the desired information and add attendees to the event.
- 5 To save the event and send out invitations, tap **Done**.

### To view a calendar event

- 1 From your Home screen, tap , then tap **Calendar**.
- 2 Tap the event that you want to view.



### To view multiple calendars

- 1 From your Home screen, tap , then find and tap **Calendar**.
- 2 Tap , then mark the checkboxes for the calendars that you want to view.



### To zoom the calendar view

- When the **Week** or the **Day** view is selected, pinch the screen to zoom in.



### To display national holidays in the Calendar application

- 1 From your Home screen, tap , then tap **Calendar**.
- 2 Tap , then tap **Settings** > **Calendar view settings**.
- 3 Tap **National holidays**.
- 4 Select an option, or a combination of options, then tap **OK**.

### To display birthdays the in Calendar application



- 1 From your Home screen, tap , then tap **Calendar**.
- 2 Tap , then tap **Settings** > **Calendar view settings**.
- 3 Drag the slider beside **Birthdays** to the right.
- 4 Tap **Birthdays**, then select the contact group for which you want to display birthdays.

### To display weather forecasts in the Calendar application

- 1 From your Home screen, tap , then tap **Calendar**.
- 2 Tap , then tap **Settings**.
- 3 Drag the slider beside **Weather forecast** to the right.
- 4 If location services are disabled, tap **Home location**, then search for the city that you want to add.

 For more information about how to enable location services, see *Using location services* on page 105.

### To change weather forecast settings in the Calendar application

- 1 From your Home screen, tap , then tap **Calendar**.
- 2 Tap , then tap **Settings** > **Calendar view settings**.
- 3 Tap **Weather forecast**.
- 4 Adjust the settings as desired.

## Alarm and clock

You can set one or several alarms and use any sound saved on your device as the alarm signal. The alarm does not sound if your device is turned off. But it does sound when the device is set to silent mode.

The alarm time format displayed is the same as the format you select for your general time settings, for example, 12-hour or 24-hour.



- 1 Access the alarm home screen
- 2 View a world clock and adjust settings
- 3 Access the stopwatch function
- 4 Access the timer function

- 5 Add a new alarm
- 6 View options
- 7 Turn an alarm on or off
- 8 Open date and time settings for the clock

#### To set a new alarm

- 1 From your Home screen, tap .
- 2 Find and tap **Alarm & clock**.
- 3 Tap **+**.
- 4 Tap **Time** and adjust the time by scrolling up and down.
- 5 Tap **Set**.
- 6 If desired, edit other alarm settings.
- 7 Tap **Done**.

#### To snooze an alarm when it sounds

- Tap **Snooze**.

#### To turn off an alarm when it sounds

- Slide  to the right.

#### To edit an existing alarm

- 1 Open the Alarm & clock application, then tap the alarm that you want to edit.
- 2 Make the desired changes.
- 3 Tap **Done**.

#### To turn on or off an alarm

- Open the Alarm & clock application, then drag the slider next to the alarm to the on or off position.

#### To delete an alarm

- 1 Open the Alarm & clock application, then touch and hold the alarm that you want to delete.
- 2 Tap **Delete alarm**, then tap **Yes**.

#### To set the sound for an alarm

- 1 Open the Alarm & clock application, then tap the alarm that you want to edit.
- 2 Tap **Alarm sound** and select an option, or tap  to select from your music files.
- 3 Tap **Done** twice.

#### To set a recurring alarm

- 1 Open the Alarm & clock application, then tap the alarm that you want to edit.
- 2 Tap **Repeat**.
- 3 Mark the checkboxes for the desired days, then tap **OK**.
- 4 Tap **Done**.

#### To activate the vibrate function for an alarm

- 1 Open the Alarm & clock application, then tap the alarm that you want to edit.
- 2 Mark the **Vibrate** checkbox.
- 3 Tap **Done**.

#### To set alarms to sound when the device is in silent mode



- 1 Open the Alarm & clock application, then tap the alarm that you want to edit.
- 2 Mark the **Alarm in silent mode** checkbox, then tap **Done**.

# Support and maintenance

## Support for your device

Use the Support application in your device to search a User guide, read troubleshooting guides, and find information about software updates and other product-related information.

### To access the Support application

- 1 From your Home screen, tap .
  - 2 Find and tap , then select the required support item.
- ! Make sure that you have a working Internet connection, preferably over Wi-Fi®, to limit data traffic charges when using the Support application.

## Help in menus and applications

Some applications and settings have help available in the options menu, which is normally indicated by  in the specific applications.

## Help us improve our software

You can enable the sending of usage info from your device so that Sony Mobile can receive anonymous bug reports and statistics that help improve our software. None of the information gathered includes personal data.

### To allow the sending of usage info

- 1 From your Home screen, tap .
- 2 Find and tap **Settings** > **About tablet** > **Usage info settings**.
- 3 Mark the **Send usage info** checkbox if it is not already marked.
- 4 Tap **Agree**.

## Computer tools

There are a number of tools available to help you connect your device to a computer and manage content such as contacts, movies, music and photos.

### PC Companion for Microsoft® Windows®

PC Companion is a computer application that gives you access to additional features and services which help you to:

- Transfer contacts, music, video and pictures to and from your old device.
- Update your device software.
- Back up content on your computer
- Sync calendars between a computer and your device.

To use the PC Companion application, you need an Internet-connected computer running one of the following operating systems:

- Microsoft® Windows® 7
- Microsoft® Windows® 8
- Microsoft® Windows Vista®
- Microsoft® Windows® XP (Service Pack 3 or higher)

The installation files for PC Companion are saved on your device and the installation is started from the device when you connect it to a computer using a USB cable.



### To install PC Companion on a PC

- 1 Connect your device to a PC using a USB cable.
- 2 Your device: Tap **Install**.
- 3 Computer: The PC Companion installation starts automatically. Follow the on-screen instructions complete the installation.

💡 You can also download PC Companion from [www.sonymobile.com/global-en/tools/pc-companion](http://www.sonymobile.com/global-en/tools/pc-companion).

### Media Go™ for Microsoft® Windows®

The Media Go™ application for Windows® computers helps you transfer photos, videos and music between your device and a computer. You can install and access Media Go™ from within the PC Companion application. To read more about how to use the Media Go™ application, go to <http://mediago.sony.com/enu/features>.

To use the Media Go™ application, you need one of these operating systems:

- Microsoft® Windows® 8 / 8.1
- Microsoft® Windows® 7
- Microsoft® Windows Vista®

### Sony Bridge for Mac

Sony Bridge for Mac is a computer application that gives you access to additional features and services which help you to:

- Transfer contacts, music, video and pictures to and from your old device.
- Transfer content from your old iPhone™, Blackberry™, Android™ or Sony device using Xperia™ Transfer.
- Update your device software.
- Transfer media files between your device and an Apple® Mac® computer.
- Back up content on an Apple® Mac® computer.

To use the Sony Bridge for Mac application, you must have an Internet-connected Apple® Mac® computer that runs Mac OS version 10.6 or later. You can download Sony Bridge for Mac at [www.sonymobile.com/global-en/tools/bridge-for-mac/](http://www.sonymobile.com/global-en/tools/bridge-for-mac/).

### To install Sony™ Bridge for Mac on an Apple® Mac® computer

- 1 Connect your device to an Apple® Mac® computer using a USB cable.
- 2 Your device: Tap **Install**.
- 3 Computer: The Sony™ Bridge for Mac installation starts automatically. Follow the on-screen instructions to complete the installation.

💡 You can also download Sony™ Bridge for Mac from [www.sonymobile.com/global-en/tools/bridge-for-mac/](http://www.sonymobile.com/global-en/tools/bridge-for-mac/).

## Updating your device

You should update the software on your device to get the latest functionality, enhancements and bug fixes in order to ensure optimal performance. When a software update is available,  appears in the status bar. You can also check for new updates manually.

The easiest way to install a software update is to do it wirelessly from your device. However, some updates are not available for wireless download. You then need to use the PC Companion application on a PC or the Sony Bridge for Mac application on an Apple® Mac® computer to update your device.

For more information about software updates, go to [www.sonymobile.com/update](http://www.sonymobile.com/update).

### To check for new software

- 1 From your Home screen, tap .
- 2 Find and tap **Update Center**.

## Updating your device wirelessly

Use the Update Center application to update your device wirelessly. It handles both application updates and system updates and can also facilitate the download of new applications developed for your device. The updates that you can download over a mobile network depend on your operator. It is recommended to use a Wi-Fi® network instead of a mobile network to download new software so that you can avoid data traffic costs.

### To download and install a system update

- 1 From your Home screen, tap .
- 2 Find and tap **Update Center**.
- 3 Select the desired system update, then tap **Download**.
- 4 When the download is finished, tap **Install** and follow the on-screen instructions to complete the installation.

### To download and install an application update

- 1 From your Home screen, tap .
- 2 Find and tap **Update Center**.
- 3 Select the desired application update, then tap **Update**. The update installs automatically after download.

### To install a new application

- 1 From your Home screen, tap .
- 2 Find and tap **Update Center**.
- 3 Select the desired application, then tap **Install**. The application installs automatically after download.

### To download and install a system update from the Notifications panel

- 1 Drag the status bar downwards to open the Notifications panel.
- 2 Scroll down and select the desired system update, then tap **Download**.
- 3 When the download is finished, tap **Install** and follow the on-screen instructions to complete the installation.

### To download and install an application update from the Notifications panel

- 1 Drag the status bar downwards to open the Notifications panel.
- 2 Scroll down and select the desired application update, then tap **Update**. The update installs automatically after download.

### To install a new application from the Notifications panel

- 1 Drag the status bar downwards to open the Notifications panel.
- 2 Scroll down and select the desired application, then tap **Install**. The new application installs automatically after download.

## Updating your device using a computer

You can download and install software updates on your device using a computer with an Internet connection. You need a USB cable and a PC running the PC Companion application or an Apple® Mac® computer running the Sony Bridge for Mac application.

-  If you don't have the PC Companion or the Sony Bridge for Mac application installed on the relevant computer, connect your device to the computer using a USB cable and follow the on-screen installation instructions.

### To update your device using a computer

- 1 Make sure you have the PC Companion application installed on your PC or the Sony Bridge for Mac application installed on the Apple® Mac® computer.
- 2 Using a USB cable, connect your device to the computer.
- 3 Computer: Launch the PC Companion application or the Sony Bridge for Mac application. After a few moments, the computer detects your device and searches for new software.
- 4 Computer: If a new software update is detected, a popup window appears. Follow the on-screen instructions to run the relevant software updates.

### Finding a lost device

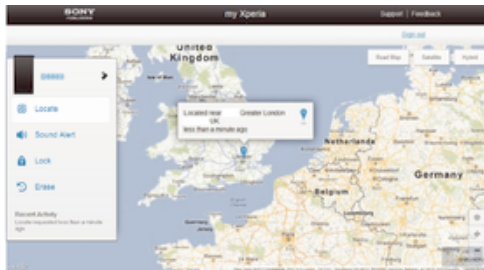

If you have a Google™ account, the my Xperia web service can help you locate and secure your device if you ever lose it. You can:

- Locate your device on a map.
  - Sound an alert even if the device is in silent mode.
  - Remotely lock the device and make the device display your contact information to anyone who finds it.
  - As a last resort, remotely clear the internal and external memory of the device.
- ! The my Xperia service may not be available in all countries/regions.

### To activate the my Xperia service

- 1 From your Home screen, tap .
  - 2 Find and tap **Settings** > **Security** > **my Xperia** > **Activate**.
  - 3 Mark the checkbox, then tap **Accept**.
- ! To verify that the my Xperia service can locate your device, go to [myxperia.sonymobile.com](http://myxperia.sonymobile.com) and sign in using the same Google™ account that you have set up on your device.
- ! If you are using a device with multiple users, my Xperia service can only be used by the owner.

### IMEI number

Every device has a unique IMEI (International Mobile Equipment Identity) number. You should keep a copy of this number. If your device is stolen, your network provider can use your IMEI number to stop the device from accessing the network in your country.

### To view your IMEI number

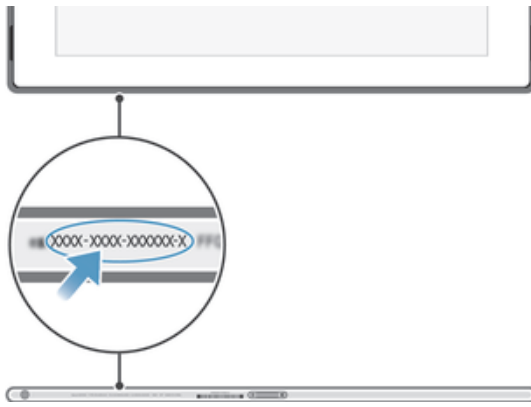

## Battery and power management

Your device has an embedded battery. You can keep track of your battery consumption and see which applications are using the most power. You can remove or restrict apps and activate a number of power saving modes to get more out of your battery. You can also view an estimate of how much battery time is left and adjust your battery settings to improve performance and make your battery last longer.

### To manage your battery consumption

- 1 From your Home screen, tap .
- 2 Find and tap **Settings** > **Power management** > **App power consumption**. An overview appears showing applications that have high data traffic rates or that you have not used for a long time.
- 3 Review the information, then act as required, for example, to uninstall an application or restrict its usage.

### To view which applications use the most battery power



- 1 From your Home screen, tap .
- 2 Find and tap **Settings** > **Power management** > **Battery usage**.

### To view the estimated battery time

- 1 From your Home screen, tap .
- 2 Find and tap **Settings** > **Power management**.

## Power saving modes

There are several power saving modes available for you to use if you want to make your battery last longer:

<b>STAMINA mode</b>	Disables Wi-Fi® and mobile data when the screen is turned off, and restricts hardware performance.  appears in the status bar when this mode takes effect.
<b>Low battery mode</b>	Modifies your device's behaviour, for example, to adjust screen brightness and the screen timeout setting, when the battery level drops below a certain percentage.  appears in the status bar when this mode takes effect.
<b>Location-based Wi-Fi</b>	Sets your device to only activate the Wi-Fi® function when it comes within range of a saved Wi-Fi® network.
<b>Queue background data</b>	Optimises outgoing traffic when the screen is off by sending data at pre-defined intervals.

### To activate a power saving mode

- 1 From your Home screen, tap .
- 2 Find and tap **Settings > Power management**.
- 3 To activate your preferred mode, drag the relevant slider to the right or mark the relevant checkbox and then confirm, if necessary.

## STAMINA mode feature overview

STAMINA mode has several features that allow you to optimise your battery performance:

<b>Extended standby</b>	Prevents applications from using data traffic by disabling Wi-Fi® and mobile data when the screen is off. You can exclude some applications and services from being paused when this feature is active.
<b>STAMINA clock</b>	Keeps network connections paused in situations where you frequently press the power key to check the time.
<b>Extended usage</b>	Restricts hardware performance when you are using your device.

### To activate STAMINA mode features

- 1 From your Home screen, tap .
- 2 Find and tap **Settings > Power management**, then tap **STAMINA mode**.
- 3 Activate STAMINA mode if it is deactivated.
- 4 Mark the checkboxes beside the features that you want to activate, then tap **Activate**, if prompted.

### To select which applications to run in STAMINA mode

- 1 From your Home screen, tap .
- 2 Find and tap **Settings > Power management**, then tap **STAMINA mode**.
- 3 Activate STAMINA mode if it is deactivated.
- 4 Make sure that the **Extended standby** checkbox is marked, then tap **Apps active in standby > Add applications**.
- 5 Scroll left or right to view all applications and services, then mark the relevant checkboxes for the applications that you want to run.
- 6 When you're finished, tap **Done**.

## Memory and storage

Your device has different types of memory and storage possibilities for photos, apps and other files:

- The internal storage is about **12 GB** and is used to store downloaded or transferred content along with personal settings and data. Examples are alarm, volume and language settings, emails, bookmarks, calendar events, photos, videos and music.
- You can use a removable memory card of up to **128 GB** to get more storage space. Most applications can read data from a memory card but only certain apps can save files to this type of memory. You can, for example, set the camera application to save photos directly to the memory card.
- The dynamic memory (RAM) is about **3 GB** and cannot be used for storage. RAM is used to handle running applications and the operating system.

! You may have to purchase a memory card separately.

💡 Read more about the use of memory in Android devices by downloading the White paper for your device at [www.sonymobile.com/support](http://www.sonymobile.com/support).

## Improving memory performance

The memory in your device tends to fill up as a result of normal usage. If the device starts to slow down, or applications suddenly shut down, you should consider the following:

- Always have more than **100 MB** of free internal storage and more than **100 MB** of free RAM.

- Close down running applications that you are not using.
- Clear the cache memory for all applications.
- Uninstall downloaded applications that you don't use.
- Transfer photos, videos and music from the internal memory to the memory card.
- If your device can't read content on the memory card, you may need to format it.

#### To view the memory status

- 1 From your Home screen, tap .
- 2 Find and tap **Settings > Storage**.

#### To view the amount of free and used RAM

- 1 From your Home screen, tap .
- 2 Find and tap **Settings > Apps > Running**.

#### To clear the cache memory for all applications

- 1 From your Home screen, tap .
- 2 Find and tap **Settings > Storage**.
- 3 Tap **Cached data > OK**.

- ! When you clear the cache memory, you don't lose any important information or settings.

#### To transfer media files to the memory card

- 1 Make sure you have a memory card inserted in your device.
- 2 From your Home screen, tap .
- 3 Find and tap **Settings > Storage > Transfer data to SD card**.
- 4 Mark the file types that you want to transfer to the memory card.
- 5 Tap **Transfer**.

#### To stop applications and services from running

- 1 From your Home screen, tap .
- 2 Find and tap **Settings > Apps > Running**.
- 3 Select an application or service, then tap **Stop**.

#### To format the memory card

- 1 From your Home screen, tap .
- 2 Find and tap **Settings > Storage > Erase SD card**.
- 3 To confirm, tap **Erase SD card > Erase everything**

- ! All content on the memory card gets erased when you format it. Make sure you make backups of all data that you want to save before formatting the memory card. To back up your content, you can copy it to a computer. For more information, see *Managing files using a computer* on page 118.

## Managing files using a computer

Use a USB cable connection between a Windows® computer and your device to transfer and manage your files. Once the two devices are connected, you can drag and drop content between your device and the computer, or between your device's internal storage and SD card, using the computer's file explorer.

If you have an Apple® Mac® computer, you can use the Sony™ Bridge for Mac application to access the file system of your device. To download Sony™ Bridge for Mac, go to [www.sonymobile.com/global-en/tools/bridge-for-mac](http://www.sonymobile.com/global-en/tools/bridge-for-mac).

This is where files are stored on your device:

- Photos and videos taken by the camera: Internal storage or SD card\DCIM.
- Downloaded files from the Internet: Internal storage or SD card\Downloads.
- Files received via Bluetooth®: Internal storage or SD card\bluetooth.
- Files received via Android Beam (NFC): Internal storage\beam.

- Screenshots taken on your device: Internal storage\DCIM\Pictures\Screenshots.
- 💡 If you're transferring music, video, pictures or other media files to your device, use the Media Go™ application on your Windows® computer. Media Go™ converts media files so that you can use them on your device. To learn more and download the Media Go™ application, go to <http://mediago.sony.com/enu/features..>

## Transferring files using Media transfer mode via Wi-Fi®

You can transfer files between your device and other MTP compatible devices, such as a computer, using a Wi-Fi® connection. Before connecting, you first need to pair the two devices. If you're transferring music, video, pictures or other media files between your device and a computer, it's best to use the Media Go™ application on the computer. Media Go™ converts media files so that you can use them on your device.

- 💡 In order to use this feature, you need a Wi-Fi® enabled device that supports Media transfer, for example, a computer running Microsoft® Windows Vista® or Windows® 7.

### To prepare to use your device wirelessly with a computer

- 1 Make sure Media transfer mode is enabled on your device. It is normally enabled by default.
- 2 Connect your device to the computer using a USB cable.
- 3 Computer: Once the name of your device appears on the screen, click *Network configuration* and follow the instructions to pair the computer and your device.
- 4 When you are finished pairing, disconnect the USB cable from both devices.

### To connect wirelessly to a paired device

- 1 Make sure Media transfer mode is enabled on your device. It is normally enabled by default.
- 2 Make sure the Wi-Fi® function is turned on.
- 3 From your Home screen, tap .
- 4 Find and tap **Settings > Xperia™ Connectivity > USB Connectivity**.
- 5 Under **Wireless Media Transfer**, select the paired device that you want to connect.
- 6 Tap **Connect**.

### To disconnect from a paired device

- 1 From your Home screen, tap .
- 2 Find and tap **Settings > Xperia™ Connectivity > USB Connectivity**.
- 3 Under **Wireless Media Transfer**, select the paired device that you want to disconnect.
- 4 Tap **Disconnect**.

### To remove a pairing with another device

- 1 From your Home screen, tap .
- 2 Find and tap **Settings > Xperia™ Connectivity > USB Connectivity**.
- 3 Select the paired device that you want to remove.
- 4 Tap **Forget**.

## Backing up and restoring content

Generally, you should not save photos, videos and other personal content solely on the internal memory of your device. If something should happen with the hardware, or if your device is lost or stolen, the data stored on its internal memory is gone forever. It is recommended to use the PC Companion or the Sony Bridge for Mac applications to make backups which save your data safely to a computer, that is, an external device. This method is especially recommended if you are updating your device software from one version to another.



Once your data is safely backed up to a computer, you can also make a quick backup of basic settings and data to the SD card in your device or to an external USB storage device by using the Backup and restore application. This backup method is useful, for example, if you are doing a factory data reset and are not updating the software version.

## Backing up data to a computer

Use the PC Companion application or the Sony Bridge for Mac application to back up data from your device to a PC or an Apple® Mac® computer. These backup applications let you back up the following types of data:

- Contacts
- Text messages
- Settings
- Media files

### To back up your data using a computer

- 1 Make sure that the PC Companion application is installed on the PC or the Sony Bridge for Mac application is installed on the Apple® Mac® computer.
- 2 Connect your device to the computer using a USB cable.
- 3 Computer: Open the PC Companion application or the Sony Bridge for Mac application.
- 4 Click **Start** to start the *Backup & Restore* application.
- 5 Tap **Back up**, then follow the on-screen instructions to back up data from your device.

### To restore your data using a computer

- 1 Make sure that the PC Companion application is installed on the PC or the Sony Bridge for Mac application is installed on the Apple® Mac® computer.
- 2 Connect your device to the computer using a USB cable.
- 3 Computer: Open the PC Companion application or the Sony Bridge for Mac application.
- 4 Click **Start** to start the *Backup & Restore* application.
- 5 Select a backup file from the backup records, then tap **Restore** and follow the on-screen instructions to restore data to your device.

## Backing up data with the Backup & Restore application

- ! You can use this method to back up and restore data between Android software versions. You cannot use it to restore data after a system upgrade.

Using the Backup & Restore application, you can back up data manually or turn on the automatic backup function to save data periodically.

The Backup & Restore application is recommended for backing up data before you do a factory data reset. With this application you can back up the following types of data to an SD card or to an external USB storage device that you have connected by cable to your device:

- Bookmarks
- Contacts
- Conversations
- Calendar
- Text messages



### To back up content using the Backup and restore application

- 1 If you are backing up content to a USB storage device, make sure the storage device is connected to your device using the appropriate cable. If you are backing up to an SD card, make sure the SD card is properly inserted in your device.
- 2 From your Home screen, tap .
- 3 Find and tap **Backup & Restore**.
- 4 Tap **Back up**, then select a backup destination and the data types that you want to back up.
- 5 Tap **Back up now**.
- 6 Enter a password for the backup, then tap **OK**.

### To restore content using the Backup and restore application

- 1 If you are restoring content from a USB storage device, make sure the storage device is connected to your device using the appropriate cable. If you are restoring content from an SD card, make sure the SD card is properly inserted in your device.
  - 2 From your Home screen, tap .
  - 3 Find and tap **Backup & Restore**.
  - 4 Tap **Restore**.
  - 5 Select the record that you want to restore from, then tap **Restore now**.
  - 6 Enter the password for the backup record, then tap **OK**.
- ! Remember that any changes you make to your data and settings after you create a backup will get deleted during a restore procedure.

## Restarting and resetting

You can force your device to shut down in situations where it stops responding or won't restart normally. No settings or personal data get deleted. You can also reset your device to its original factory settings, with or without deleting all of your personal data. This action is sometimes necessary if your device stops functioning properly.

- ! Your device may fail to restart if the battery level is low. Connect your device to a charger and try restarting again.

### To force your device to restart

- 1 Press and hold down the power key .
- 2 In the menu that opens, tap **Restart**, then tap **OK** to confirm. The device restarts automatically.

### To force the device to shut down

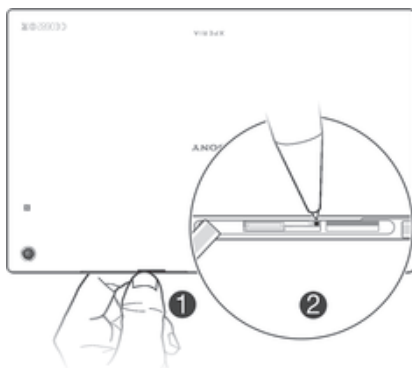

- 1 Detach the cover of the micro SIM card slot.
  - 2 Using the tip of a pen or a similar object, press and hold down the OFF button until the device shuts down.
- ! Do not use overly sharp objects that could damage the OFF button.

### To perform a factory data reset

- ! To avoid permanent damage to your device, do not restart your device while a reset procedure is underway.
  - 1 Before you start, make sure to back up any important data that is saved on the internal memory of your device to a memory card or other non-internal memory.
  - 2 From your Home screen, tap .
  - 3 Find and tap **Settings > Backup & reset > Factory data reset**.
  - 4 To delete information, such as music and pictures, from your internal storage, mark the relevant checkbox.
  - 5 Tap **Reset tablet**.
  - 6 If required, draw your screen unlock pattern, or enter your screen unlock password or PIN to continue.
  - 7 To confirm, tap **Erase everything**.
- 💡 If you forget your screen unlock password, PIN or pattern in step 6, you can use the device repair feature in the *PC Companion* or *Sony Bridge for Mac* applications to erase this security layer. By running the repair feature, you are reinstalling software for your device and you may lose some personal data in the process.

### Using your device in wet and dusty conditions

- ! To ensure the water resistance of your device, all covers, including the covers for the micro USB port and the memory card slot, must be firmly closed.

Your smart device is waterproof and dust resistant in compliance with the Ingress Protection (IP) ratings IP55 and IP58, as explained in the table below. To view more specific IP information about your device, go to [www.sonymobile.com/global-en/legal/testresults/](http://www.sonymobile.com/global-en/legal/testresults/) and click on the relevant device name.

These specific IP ratings mean that your device is dust resistant and is protected against low pressure water stream as well as against the effects of immersion for 30 minutes in fresh (non-saline) water up to 1.5 metres deep.

You can use your device:

- in dusty environments, for example, on a windy beach.
- when your fingers are wet.
- in some extreme weather conditions, for example, when it's snowing or raining.
- in fresh (non-saline) water depths of 1.5 metres or less, for example, in a fresh water lake or river.
- in a chlorinated swimming pool.

Even if your device is resistant to dust and water, you should avoid exposing it unnecessarily to environments with excessive dust, sand and mud or to moist environments with extreme high or low temperatures. The waterproof ability of the micro USB port, the memory card slot and the headset jack cannot be guaranteed in all environments or conditions.

Never immerse your device in salt water or let the micro USB port or headset jack come in contact with salt water. For example, if you're at the beach, remember to keep your device away from the sea water. Also, never expose the device to any liquid chemicals. For example, if you're washing dishes by hand using liquid detergent, avoid bringing your device in contact with the detergent. After exposure to non-fresh water, rinse your device using fresh water.

Normal wear and tear along with damage to your device can reduce its ability to resist dust or moisture. After using the device in water, dry off the areas around all covers, including the covers for the micro USB port, and the memory card slot.

If the speaker or microphone get wet, their function may be impacted until the water has completely dried. Please note that the drying time can be up to three hours depending on the environment. During this time, you can, however, use other features in the device that do not utilise the speaker or microphone. All compatible

accessories, including batteries, chargers, handsfree devices and micro USB cables, are not waterproof and dust resistant on their own.

Your warranty does not cover damage or defects caused by abuse or improper use of your device (including use in environments where the relevant IP rating limitations are exceeded). If you have any further questions about the use of your products, refer to our Customer support service for help. Also, for warranty information, refer to the *Important information* which can be accessed via the Setup guide in your device.

## IP (Ingress Protection) rating

Your device has an IP rating, which means it has undergone certified tests to measure its resistance levels to both dust and water. The first digit in the two-digit IP rating indicates the level of protection against solid objects, including dust. The second digit indicates how resistant the device is to water.

Resistance to solid objects and dust	Resistance to water
IP0X: No special protection	IPX0: No special protection
IP1X: Protected against solid objects > 50 mm in diameter	IPX1: Protected against dripping water
IP2X: Protected against solid objects > 12.5 mm in diameter	IPX2: Protected against dripping water when tilted up to 15 degrees from normal position
IP3X: Protected against solid objects > 2.5 mm in diameter	IPX3: Protected against spraying water
IP4X: Protected against solid objects > 1 mm in diameter	IPX4: Protected against splashing water
IP5X: Protected against dust; limited ingress (no harmful deposit)	IPX5: Protected against water jet spray for at least 3 minutes
IP6X: Dust tight	IPX6: Protected against heavy jet spray for at least 3 minutes
	IPX7: Protected against the effects of immersion in up to 1 metre of water for 30 minutes
	IPX8: Protected against the effects of continued immersion in water depths greater than 1 metre. The exact conditions are specified for each device by the manufacturer.

! For more information, go to [www.sonymobile.com/testresults](http://www.sonymobile.com/testresults).

## Recycling your device

Got an old device lying around the house? Why not recycle it? By doing so, you will help us reuse its materials and components, and you'll protect the environment, too! Find out more about the recycling options in your region at [www.sonymobile.com/recycle](http://www.sonymobile.com/recycle).

## Limitations to services and features

Some of the services and features described in this User guide are not supported in all countries/regions or by all networks and/or service providers in all areas. Without limitation, this applies to the GSM International Emergency Number, 112. Please contact your network operator or service provider to determine availability of any specific service or feature and whether additional access or usage fees apply.

Use of certain features and applications described in this guide may require access to the Internet. You may incur data connection charges when you connect to the Internet from your device. Contact your wireless service provider for more information.

## Legal information

### SonySGP521

This User guide is published by Sony Mobile Communications AB or its local affiliated company, without any warranty. Improvements and changes to this User guide necessitated by typographical errors, inaccuracies of current information, or improvements to programs and/or equipment, may be made by Sony Mobile Communications AB at any time and without notice. Such changes will, however, be incorporated into new editions of this User guide. All illustrations are for illustration purposes only and may not accurately depict the actual device.

All product and company names mentioned herein are the trademarks or registered trademarks of their respective owners. All other trademarks are property of their respective owners. Any rights not expressly granted herein are reserved. Visit [www.sonymobile.com/us/legal/](http://www.sonymobile.com/us/legal/) for more information.

This User guide may reference services or applications provided by third parties. Use of such programming or services may require separate registration with the third party provider and may be subject to additional terms of use. For applications accessed on or through a third-party website, please review such websites' terms of use and applicable privacy policy in advance. Sony does not warrant or guarantee the availability or performance of any third-party websites or offered services.

Your mobile device has the capability to download, store and forward additional content, for example, ringtones. The use of such content may be restricted or prohibited by rights of third parties, including but not limited to restriction under applicable copyright laws. You, and not Sony, are entirely responsible for additional content that you download to or forward from your mobile device. Prior to your use of any additional content, please verify that your intended use is properly licensed or is otherwise authorized. Sony does not guarantee the accuracy, integrity or quality of any additional content or any other third party content. Under no circumstances will Sony be liable in any way for your improper use of additional content or other third party content.

Visit [www.sonymobile.com/](http://www.sonymobile.com/) for more information.

This product is protected by certain intellectual property rights of Microsoft. Use or distribution of such technology outside of this product is prohibited without a licence from Microsoft.

Content owners use Windows Media digital rights management technology (WMDRM) to protect their intellectual property, including copyrights. This device uses WMDRM software to access WMDRM-protected content. If the WMDRM software fails to protect the content, content owners may ask Microsoft to revoke the software's ability to use WMDRM to play or copy protected content. Revocation does not affect unprotected content. When you download licences for protected content, you agree that Microsoft may include a revocation list with the licences. Content owners may require you to upgrade WMDRM to access their content. If you decline an upgrade, you will not be able to access content that requires the upgrade.

This product is licensed under the MPEG-4 visual and AVC patent portfolio licences for the personal and non-commercial use of a consumer for (i) encoding video in compliance with the MPEG-4 visual standard ("MPEG-4 video") or the AVC standard ("AVC video") and/or (ii) decoding MPEG-4 or AVC video that was encoded by a consumer engaged in a personal and non-commercial activity and/or was obtained from a video provider licenced by MPEG LA to provide MPEG-4 and/or AVC video. No licence is granted or shall be implied for any other use. Additional information including that relating to promotional, internal and commercial uses and licensing may be obtained from MPEG LA, L.L.C. See <http://www.mpegla.com>. MPEG Layer-3 audio decoding technology licenced from Fraunhofer IIS and Thomson.

**SONY MOBILE WILL NOT BE LIABLE FOR ANY LOSS, ERASE AND/OR DATA-OVERWRITING OF PERSONAL DATA OR FILES STORED ON YOUR DEVICE (INCLUDING BUT NOT LIMITED TO CONTACTS, MUSIC TRACKS AND PICTURES) ARISING OUT OF ANY UPDATE OF YOUR DEVICE BY ANY OF THE METHODS DESCRIBED IN THIS USER GUIDE OR DOCUMENTATION. IN NO EVENT SHALL SONY MOBILE'S OR ITS SUPPLIERS' TOTAL LIABILITY TO YOU FOR ANY AND ALL DAMAGES, LOSSES AND CAUSES OF ACTION (WHETHER IN CONTRACT OR TORT, INCLUDING, BUT NOT LIMITED TO NEGLIGENCE OR OTHERWISE) EXCEED THE AMOUNT ACTUALLY PAID BY YOU FOR YOUR DEVICE.**

© Sony Mobile Communications AB, 2014.

All rights reserved